

Welcome to

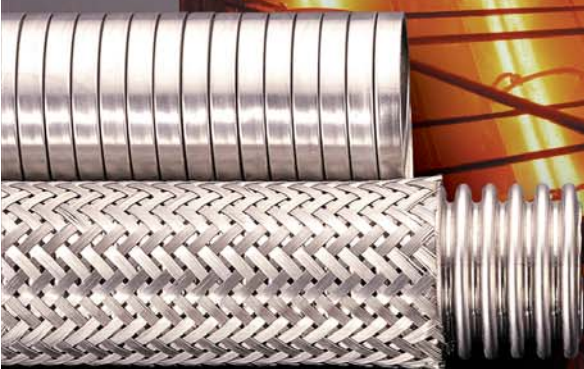

Hose Master Inc.

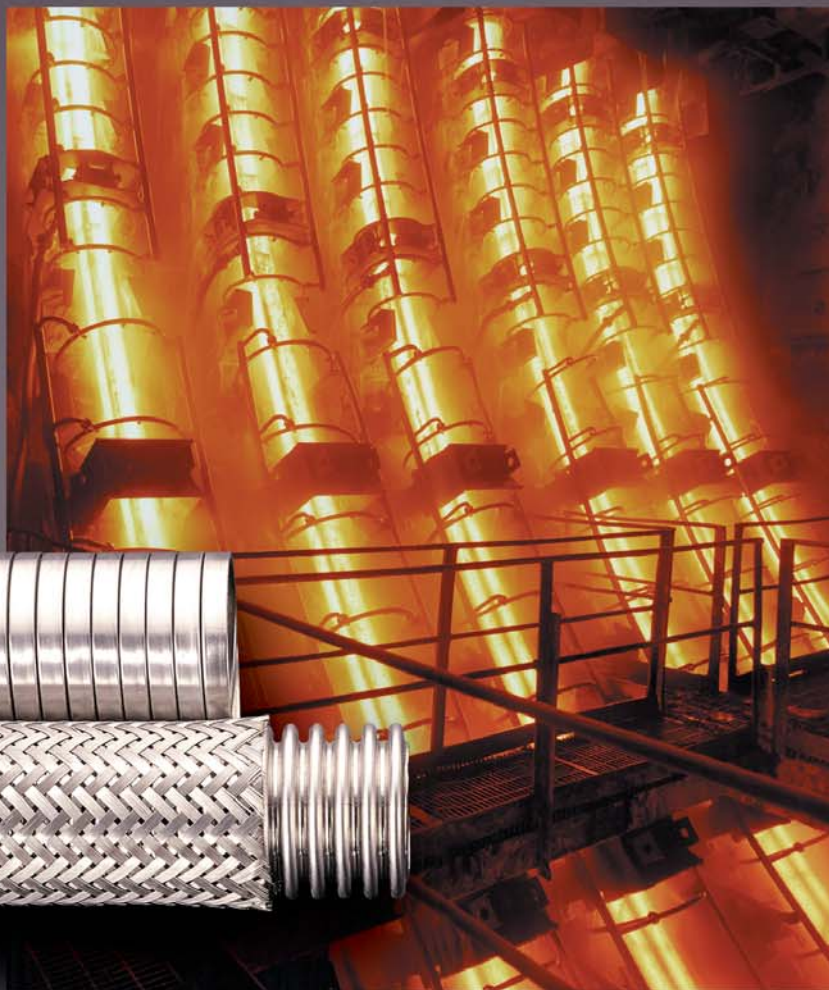

Industrial Metal Hose Products

Click on your selection from the following menu:

[When to use Metal Hose](#)

[Table of Contents](#)

[Hose Master Benefits](#)

[Corrugated Metal Hose](#)

[Stripwound Metal Hose](#)

[Technical Information](#)

[Exit](#)

Table of Contents

Click on a main section or subsection from the following menu:

Hose Master Benefits

Facility	.3
Service	.4
Product Line	.5
Fabrication	.6
Engineering	.7
Quality	.8

Corrugated Metal Hose

Designing an Assembly	.9
Hose	.11
Selecting a Hose	.13
Products	.14
Specifications by Diameter	.23
Fittings	.29
Length	.34
Fabrication Options	.35
Accessories	.39

Stripwound Metal Hose

Designing an Assembly	.43
Hose	.45
Products	.46
Fittings	.51
Length	.54
Fabrication Options	.55
Accessories	.57

Technical Information

Definitions	.60
Geometric Formulas	.65
Conversions	.66
Working Pressure Derating Factor	.67
Velocity in Metal Hose	.67
Minimum Bend Radius Charts	.68
Vibration	.71
Do's and Don'ts	.72
Thread Allowance	.72
Length Calculations	.73
Pressure Drop	.76
Saturated Steam	.77
Thermal Expansion of Pipe	.77
How to Order an Assembly	.78

Metal Hose



When to use Metal Hose:

There are many different types of hose available on the market. They include metal, rubber, composite, PTFE and fabric. The decision of which hose type to buy depends on the application for which the hose is being used. Generally, there are eight factors that should alert you to consider using metal hose:

1. **Temperature Extremes** - If either the temperature of the media going through the hose or the surrounding atmospheric temperature is very cold or hot, metal may be the only material that can withstand the temperature extremes.
2. **Chemical Compatibility** - Metal hose can handle a wider variety of chemicals than most of the other hose types. If the hose will be exposed to aggressive chemicals (either internally or externally), metal hose should be considered.
3. **Permeation Concerns** - Non-metal hose is susceptible to having gases permeate through the hose wall and into the atmosphere. Metal hose, on the other hand, does not allow permeation. If containing the gases inside the hose is important, metal hose may be required.
4. **Potential for Catastrophic Failure** - When a metal hose fails, it usually develops small holes or cracks. Other hose types tend to develop larger cracks or come apart completely. If a sudden failure of the hose can be catastrophic, a metal hose may help minimize the effects of a failure by leaking product at a slower rate.
5. **Abrasion and Overbending Concerns** - To prevent abrasion and overbending, a metal hose can be used as a protective cover over wires or even other hoses.
6. **Fire Safety** - Other hose types will melt when exposed to fire while metal hose maintains its integrity up to 1200° F.
7. **Achieving Full Vacuum** - Under full vacuum, metal hose maintains its shape while other hose types may collapse.
8. **Flexibility in Fitting Configuration** - Virtually any type of fitting can be attached to metal hose while other hose types require special shanks and collars.

Types of Metal Hose:

1. **Corrugated Metal Hose** - Corrugated metal hose can handle high pressures and is gas tight. It is excellent for gas and liquid transfers.
2. **Stripwound Metal Hose** - Stripwound metal hose, although not gas tight, is rugged, making it excellent for use as a guard, an open-ended exhaust hose, and for the transfer of dry bulk materials.

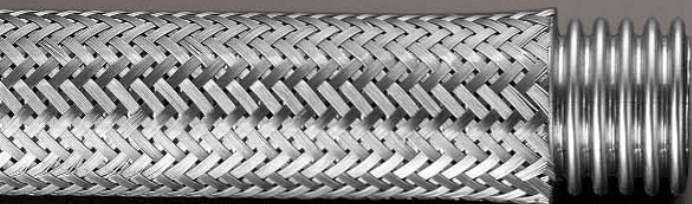

Hose Master Benefits

Facility:

Hose Master's 210,000 square foot facility is located in Cleveland, Ohio. We employ a large well-trained staff and use state-of-the-art manufacturing equipment. Hose Master maintains an international presence through an affiliation with Tubiflex, S.p.a. in Turin, Italy.



Hose Master Benefits

Service:

Hose Master's experienced Customer Service Department, working in conjunction with the Field Sales Support Group and Engineering Staff, will assist in designing hose assemblies to meet your specific application and delivery requirements.



Call 1-800-221-2319
www.hosemaster.com



Hose Master Benefits

Product Line:

Utilizing innovative manufacturing technologies such as a proprietary hydroforming process, Hose Master produces the highest quality corrugated and stripwound hose in a wide variety of alloys.



Hose Master Benefits

Fabrication:

Hose Master's large Fabrication Department has the ability to supply large volumes of high-quality hose assemblies fabricated by ASME Section IX certified welders.

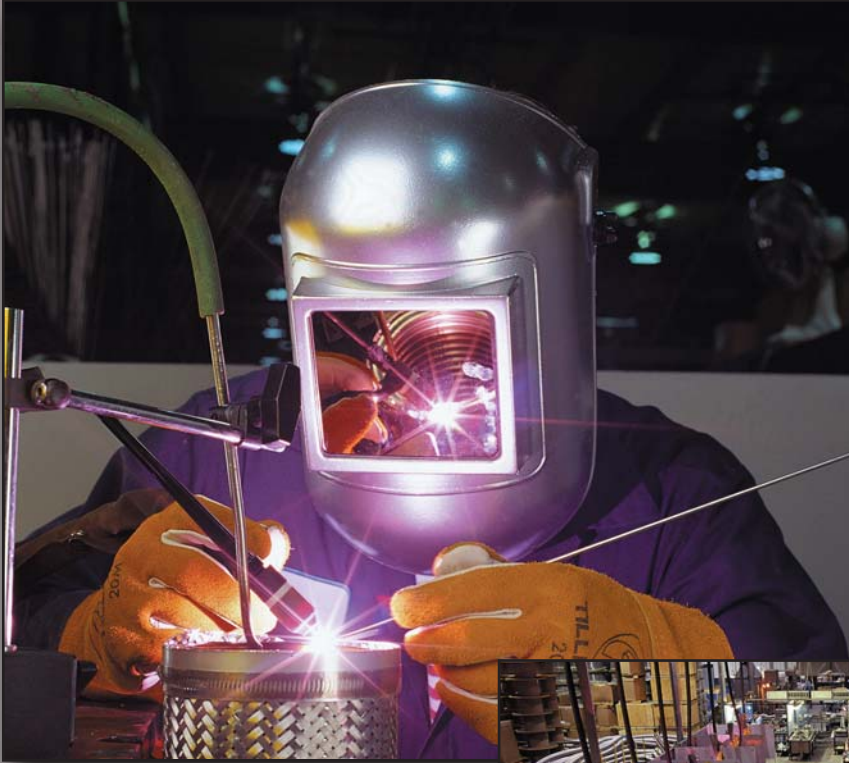

Call 1-800-221-2319
www.hosemaster.com



Hose Master Benefits

Engineering:

Utilizing a staff of experienced engineers and technicians, Hose Master is able to design and build state-of-the-art manufacturing equipment, design and test new products, and perform in-depth product analysis.



Hose Master Benefits

Quality:

Hose Master's dedication to quality has earned a variety of approvals including ISO registration. In fact, Hose Master was the first hose company in America to be ISO registered.



Approvals:



Members of:



Call 1-800-221-2319
www.hosemaster.com



Corrugated Metal Hose (Designing an Assembly)

There are many components in a metal hose assembly and care should be taken when selecting each of them. Moreover, the components have their own unique technical limitations so it is important to make sure each of the components is compatible with your application. In much the same way as a “chain is as strong as its weakest link”, a metal hose assembly will only perform to the limits of its weakest component.

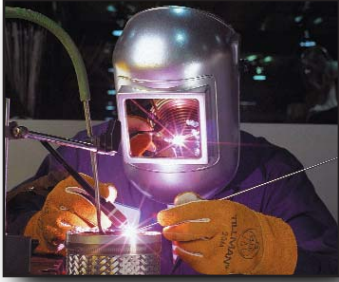

Once the components have been selected, the quality and skill of the fabricator assembling the components becomes important. The procedures and care used when fabricating assemblies also has a dramatic effect on the assembly's overall performance.



Hose Master has invested a considerable amount of resources researching metal hose fabrication and developing a state-of-the-art fabricating center. In addition, we share the welding technology we have developed with our fabricating distributors. All of this is done to promote quality and consistency in fabricating metal hose assemblies.

In this section, we will discuss the various components that make up a corrugated metal hose assembly, and what information a metal hose fabricator will need in order to make an assembly for your application. If you need assistance determining the information, we have also included an explanation of how to analyze the application and make the appropriate selections.



Specifying a Metal Hose Assembly:

In order to make an assembly, the fabricator will need answers to the following five questions. For more information about any of these questions, or for a list of available options, consult the referenced pages listed next to each topic.

1. Hose (type, alloy, and size): page 11
2. End fittings (type, alloy, and size for each end): page 29
3. Length of the assembly (either overall length or live length): page 34
4. Fabrication options: page 35
5. Accessories: page 39

If you have the answers to these questions, a metal hose fabricator will be able to make the assembly. If you do not know the answers to all five questions, you will need to obtain them. The next section is designed to help you determine the answers.

Corrugated Metal Hose (Designing an Assembly)

Analyzing an Application:

S.T.A.M.P.E.D.

To properly design a metal hose assembly for a particular application, the following design parameters must be determined. To help remember them, they have been arranged to form the acronym “S.T.A.M.P.E.D.”

1. **Size** – The diameter of the connections in which the assembly will be installed is needed to provide a proper fit. This information is required.
2. **Temperature** – As the temperature to which the assembly is exposed (internally and externally) increases, the strength of the assembly’s components decreases. Also, the coldest temperature to which the hose will be exposed can affect the assembly procedure and/or fitting materials. If you do not provide this information it will be assumed that the temperatures are 70°F.
3. **Application** – This refers to the configuration in which the assembly is installed. This includes both the dimensions of the assembly as well as the details of any movement that the assembly will experience. This information is necessary to calculate assembly length and required flexibility.
4. **Media** – Identify all chemicals to which the assembly will be exposed, both internally and externally. This is important since you must be sure that the assembly’s components are chemically compatible with the media going through the hose as well as the environment in which the hose is installed. If no media is given, it will be assumed that both the media and the external environment are compatible with all of the available materials for each component.
5. **Pressure** – Identify the internal pressure to which the assembly will be exposed. Also, determine if the pressure is constant or if there are cycles or spikes. This information is important to determine if the assembly is strong enough for the application. If no pressure is given it will be assumed that the pressure is low and there are no pressure surges or spikes.
6. **End Fittings** – Identify the necessary end fittings. This is required since fittings for the assembly must be chosen to properly fit the mating connections.
7. **Dynamics** – Identify the velocity at which the media will flow through the assembly. Since corrugated metal hose does not have a smooth interior, rapid media flow can set up a resonant frequency that will cause the hose to vibrate and prematurely fail. If no velocity is given, it will be assumed that the velocity is not fast enough to affect the assembly’s performance.

To make gathering this information easier, Hose Master has provided a convenient worksheet to help select components on page 78.

Corrugated Metal Hose (Hose)



Hydroformed Corrugation Process:

A. Tube

The manufacturing process of corrugated metal hose starts with stainless steel strip that is rolled and the edges welded together to form a thin-walled, gas-tight tube. Hose Master offers:



High quality steel strip



Rolled to form a tube



Strong, clean, non-oxidized seam weld

B. Hose

After the tube has been welded, corrugations are formed into the tube to make it flexible. There are two corrugation profiles, annular and helical.

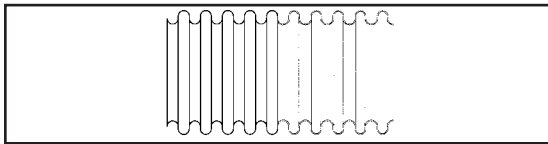

Annular profile - Independent corrugations, straight and parallel

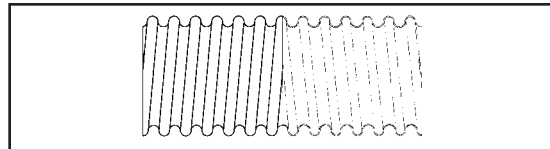

Helical profile - One continuous corrugation that spirals around the hose.

Corrugations are formed into the tube either mechanically or hydraulically ("Hydroforming").

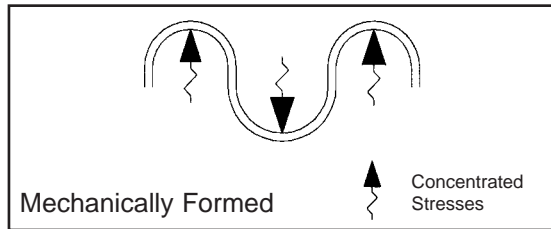
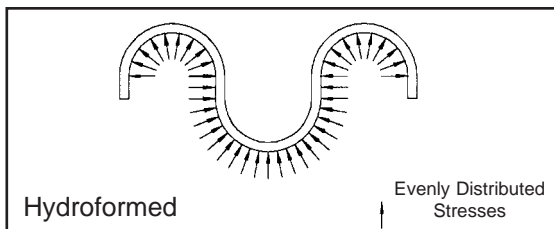

Hydroforming:

- Enhances flexibility and cycle life.
 - Maintains wall thickness.
 - Reduces concentrated residual stress.
 - Minimizes work hardening.
- Is a clean process.
 - Hydroforming uses water to form the hose while most other processes require lubrication.

Hose Master Inc. is the only American metal hose manufacturer to hydroform metal hose.

Corrugated Metal Hose (Hose)

Corrugated Strip Process (Extraflex/Hydraflex):

In addition to our line of annular, corrugated hose, Hose Master offers two helical hoses specially designed to maximize performance without the drawbacks of traditional, mechanically-formed, helical hose. Rather than welding a tube and mechanically forming the corrugation, these products are made from stainless steel strip that is formed before welding. Because it is not mechanically formed from a tube, it is extremely flexible and does not contain all the residual stresses like traditional mechanically-formed helical hose.

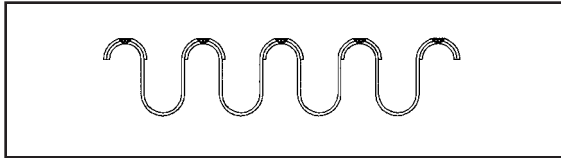

Extraflex profile

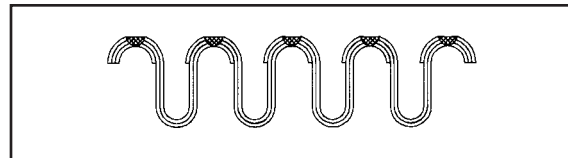

Hydraflex profile

Both Extraflex and Hydraflex are made by pre-forming the stainless steel strip, overlapping the material, and then continuously resistance welding the seam together. While Extraflex is made with one ply of stainless steel, Hydraflex is made with two plies for higher pressure ratings.

Braiding Process:

To give corrugated hose the ability to withstand pressure, stainless steel wire is braided over the hose. Hose may be single braided (one layer of braid) or double braided (two layers of braid) to achieve even greater working pressures. Braided braid is used on large diameter hose.

Designing the proper braid for each type of corrugated hose requires sophisticated engineering to maintain the proper balance between the braid strength and the hose flexibility. Hose Master's braid packages offer several advantages:

1. High Percentage Braid Coverage – Hose Master has a high percentage of braid coverage yielding better cycle life and protection against damage to the hose.
2. Machine Braided Hose – Hose Master weaves the braid directly onto the hose ensuring that the braid fits tightly against the hose, preventing potential hose deformation or squirm.

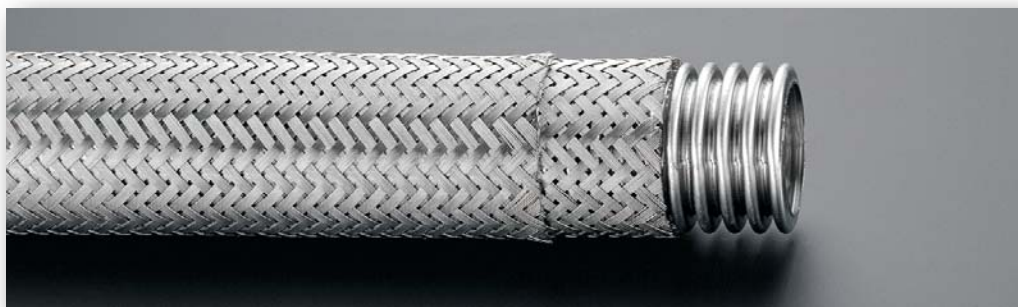

Corrugated metal hose with double braid.

Corrugated Metal Hose (Selecting a Hose)



When selecting a hose, you must consider three variables: pressure carrying capability, flexibility, and chemical compatibility.

- **Pressure Carrying Capability** – The hose must be strong enough to handle the pressures to which it will be exposed. To determine hose pressure capability, consult the catalog “Maximum Working Pressure” stated for the hose. The Maximum Working Pressure must be reduced for each of the following circumstances:

Temperature – As temperature increases, hose working pressure decreases. After you have determined the proper alloy (see “Chemical Compatibility” below) go to the “Temperature Derating” table on page 67 and match the alloy of the hose and braid with the highest temperature to which they will be exposed (either internally or externally) to obtain the proper derating factors. Then multiply the hose’s Maximum Working Pressure by the most limiting temperature derating factor.

Dynamic Pressure – Pulsating, surge, or shock pressures, like those encountered with quick opening or closing valves, can inflict severe damage on a hose. If your application entails pulsating pressures, the working pressure should be derated by 1/2. If your application entails shock pressures, derate the stated working pressure to 1/6 of its value.

Example: 1” Annuflex hose - T321 stainless steel hose and T304 stainless steel braid @ 300°F with shock pressures.

Catalog Maximum Working Pressure = 718 psi.

Temperature Derating Factor at 300° F.= 0.86; and the Pressure Derating Factor =1/6.

Maximum Application Working Pressure = 718 psi x 0.86 x 1/6 =102.91 psi.

- **Flexibility** – Confirm that the hose’s minimum bend radius is less than the bend radius required. Keep in mind that the hose’s minimum bend radius will change with pressure. To determine the minimum bend radius, go to the charts beginning on page 68 for the type of hose being used and match the line for the hose’s I.D. with your application’s pressure requirements. The chart will show you the recommended minimum bend radius. Care should also be taken for applications with vibration. Consult page 71 for recommendations.
- **Chemical Compatibility** – You must choose a material for the hose and braid that is compatible with the media being conveyed through the hose as well as the environment in which the hose is installed. When determining chemical compatibility it is important to know the temperature and concentration of the chemical(s). Although there are many resources to confirm chemical compatibility, two of the industry standards that you may use are the National Association of Corrosion Engineers (NACE) and the Compass Corrosion Guides. You may also contact our Customer Service Department which can check these sources for you.

Corrugated Metal Hose (Products)

Flexibility

Working Pressure

Feature: *Standard Product*

Annuflex is the standard of Hose Master’s extensive line of high performance annular corrugated stainless steel hose. Proprietary hydroforming technology ensures the excellent cycle life of the hose, with minimum effort to flex or bend the hose15

Flexibility

Working Pressure

Feature: *Most Pliable*

Masterflex is the most pliable product of the annular family of hydroformed hose16

Flexibility

Working Pressure

Feature: *“Stay-Put” Application*

Formaflex has the “stay-put” characteristics required for stress-free connections between piping systems and rotary joints or other similar static applications17

Flexibility

Working Pressure

Feature: *High Pressure*

Pressureflex is Hose Master’s hydroformed, annular, heavy-wall, corrugated metal hose specifically designed for higher pressure applications.18

Flexibility

Working Pressure

Feature: *Chemical Resistance*

ChemKing® is Hose Master’s chemical transfer, hydroformed hose. ChemKing® offers excellent corrosion resistance to many of the most severe applications found in chemical processing19

Flexibility

Working Pressure

Feature: *Bronze Alloy*

Bronzeflex is a heavy-duty corrugated hose designed for use in those applications that specifically require bronze hose.20

Flexibility

Working Pressure

Feature: *Helical/Flexible*

Extraflex is a spirally-welded, helical corrugated hose specifically designed to achieve extreme flexibility while maintaining good pressure ratings.21

Flexibility

Working Pressure

Feature: *Helical/High Pressure*

Hydrflex is a double wall, spirally-welded, helical corrugated hose specifically designed for high-pressure applications that also require good flexibility22

Note: Product specifications are subject to change.

Corrugated Metal Hose (Products)

ANNUFLEX

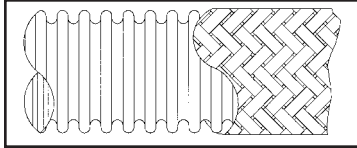

Annuflex is the foundation of Hose Master's extensive line of annular hydroformed products. The hydroforming process produces a hose with minimal residual stress, uniform wall thickness throughout the corrugations, and minimal work hardening. This process provides a very flexible, long lasting corrugated metal hose.

Explanation of **Annuflex** Part Numbers:

AF _____ **7** _____
 Material Code Braid Code

Material Codes:
4 - T321 Stainless Steel
5 - T316L Stainless Steel
7 - T304L Stainless Steel

Braid Codes
00 - Unbraided
50 - T304 Single Braid
55 - T304 Double Braid

Example: AF4750 = T321 Stainless Steel, annular, corrugated metal hose with a single T304 Stainless Steel Braid.

*T316 Braid available upon request.

Inside Diameter (in.)	Number of Braids (#)	Outside Diameter (in.)	Static Min. Bend Radius (in.)	Dynamic Min. Bend Radius (in.)	Maximum Working Pressure (psi)	Burst Pressure (psi)	Weight Per Foot (lbs.)
1/4	0	0.41	1.0	4.5	90	7233	0.04
	1	0.47			1800		0.11
	2	0.53			2700		0.18
3/8	0	0.65	1.2	5.0	70	6230	0.10
	1	0.71			1558		0.20
	2	0.77			2336		0.30
1/2	0	0.77	1.5	5.5	70	4743	0.11
	1	0.83			1186		0.22
	2	0.89			1779		0.33
5/8	0	0.96	1.8	7.0	57	4820	0.17
	1	1.02			1205		0.33
	2	1.08			1808		0.49
3/4	0	1.16	2.1	8.0	43	3591	0.19
	1	1.22			898		0.37
	2	1.28			1347		0.55
1	0	1.47	2.7	9.0	43	2872	0.26
	1	1.53			718		0.50
	2	1.59			1077		0.74
1 1/4	0	1.75	3.1	10.0	43	2581	0.29
	1	1.83			645		0.61
	2	1.91			968		0.93
1 1/2	0	2.08	3.9	11.0	28	2125	0.47
	1	2.16			531		0.85
	2	2.24			797		1.23
2	0	2.61	5.1	13.0	14	1797	0.59
	1	2.69			449		1.11
	2	2.77			674		1.63
2 1/2	0	3.40	6.8	16.0	14	1669	0.84
	1	3.50			417		1.64
	2	3.60			626		2.44
3	0	3.88	7.8	18.0	14	1384	1.18
	1	3.98			346		2.06
	2	4.08			519		2.94
4	0	4.96	9.8	22.0	14	1194	1.41
	1	5.06			299		2.47
	2	5.16			448		3.53
5	0	6.00	12.8	28.0	14	1099	2.18
	1	6.12			275		3.61
	2	6.24			412		5.04
6	0	7.01	14.8	32.0	11	839	2.69
	1	7.13			210		4.44
	2	7.25			315		6.19
8*	0	9.08	20.0	40.0	3	850	5.32
	1	9.44			212		7.66
10*	0	11.10	25.0	50.0	2	700	8.71
	1	11.49			175		12.65
12*	0	13.22	30.0	60.0	2	640	11.58
	1	13.51			160		17.53

*Supplied with braided braid.

Notes: The minimum bend radius is measured from the centerline of the hose. The minimum bend radius increases with pressure (see chart on page 68). The working pressure decreases with temperature (obtain derating factor on page 67). For rapid pressure fluctuations consult the factory.

 **Call 1-800-221-2319**
www.hosemaster.com

Corrugated Metal Hose (Products)

MASTERFLEX

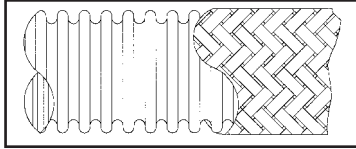

Masterflex is manufactured using the same high quality process used to make Annuflex hose, but the number of corrugations per foot is increased to allow for greater flexibility.

Explanation of **Masterflex** Part Numbers:

AF 5
Material Code Braid Code

Material Codes:
4 - T321 Stainless Steel
5 - T316L Stainless Steel
7 - T304L Stainless Steel

Braid Codes
00 - Unbraided
50 - T304 Single Braid
55 - T304 Double Braid

Example: AF4550 =
T321 Stainless Steel, annular,
corrugated metal hose with a
single T304 Stainless Steel Braid.

*T316 Braid available upon request.

Inside Diameter (in.)	Number of Braids (#)	Outside Diameter (in.)	Static Min. Bend Radius (in.)	Dynamic Min. Bend Radius (in.)	Maximum Working Pressure (psi)	Burst Pressure (psi)	Weight Per Foot (lbs.)
1/4	0	0.42	0.9	3.7	90	7233	0.07
	1	0.48			1800		0.14
	2	0.54			2700		0.21
3/8	0	0.65	1.0	4.0	70	6230	0.20
	1	0.71			1558		0.30
	2	0.77			2336		0.40
1/2	0	0.77	1.2	4.4	70	4743	0.22
	1	0.83			1186		0.33
	2	0.89			1779		0.44
5/8	0	0.96	1.4	5.6	57	4820	0.31
	1	1.02			1205		0.47
	2	1.08			1808		0.63
3/4	0	1.16	1.7	6.4	43	3591	0.33
	1	1.22			898		0.51
	2	1.28			1347		0.69
1	0	1.47	2.1	7.1	43	2872	0.45
	1	1.53			718		0.69
	2	1.63			1077		0.93
1 1/4	0	1.75	2.5	7.9	43	2581	0.56
	1	1.83			645		0.88
	2	1.91			968		1.20
1 1/2	0	2.08	3.1	8.7	28	2125	0.82
	1	2.16			531		1.20
	2	2.24			797		1.58
2	0	2.61	4.0	10.3	14	1797	0.95
	1	2.69			449		1.47
	2	2.77			674		1.99
2 1/2	0	3.40	5.4	12.8	14	1669	1.29
	1	3.50			417		2.09
	2	3.60			626		2.89
3	0	3.88	6.3	14.5	14	1384	1.84
	1	3.98			346		2.72
	2	4.08			519		3.60
4	0	4.96	7.7	17.4	14	1194	2.33
	1	5.06			299		3.39
	2	5.16			448		4.45
5	0	6.00	10.0	21.9	14	1099	3.64
	1	6.12			275		5.07
	2	6.24			412		6.50
6	0	7.01	11.6	25.0	11	839	4.16
	1	7.13			210		5.91
	2	7.25			315		7.66

Notes: The minimum bend radius is measured from the centerline of the hose. The minimum bend radius increases with pressure (see chart on page 68). The working pressure decreases with temperature (obtain derating factor on page 67). For rapid pressure fluctuations consult the factory.

Corrugated Metal Hose

Call 1-800-221-2319
www.hosemaster.com



Corrugated Metal Hose (Products)

FORMAFLEX

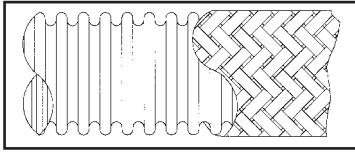

Formaflex is Hose Master's "stay-put" annular corrugated metal hose. Formaflex is designed to bend and stay in one position, providing a stress-free connection between piping systems.

Explanation of **Formaflex** Part Numbers:

AF _____ **9** _____
 Material Code Braid Code

Material Codes:
 4 - T321 Stainless Steel
 5 - T316L Stainless Steel

Braid Codes
 00 - Unbraided
 50 - T304 Single Braid
 55 - T304 Double Braid

Example: AF4950 = T321 Stainless Steel, annular, corrugated metal hose with a single T304 Stainless Steel Braid.

Inside Diameter (in.)	Number of Braids (#)	Outside Diameter (in.)	Static Min. Bend Radius (in.)	Maximum Working Pressure (psi)	Burst Pressure (psi)	Weight Per Foot (lbs.)
1/4	0	0.41	1.0	90	3600	0.04
	1	0.47		900		0.11
3/8	0	0.65	1.2	70	3200	0.10
	1	0.71		800		0.17
1/2	0	0.77	1.5	70	2660	0.11
	1	0.83		665		0.19
5/8	0	0.96	1.8	57	2000	0.17
	1	1.02		500		0.26
3/4	0	1.16	2.1	43	1520	0.19
	1	1.22		380		0.29
1	0	1.47	2.7	43	1420	0.26
	1	1.53		355		0.42
1 1/4	0	1.75	3.1	43	1120	0.29
	1	1.81		280		0.47
1 1/2	0	2.08	3.9	28	1056	0.47
	1	2.14		264		0.71
2	0	2.61	5.1	14	884	0.59
	1	2.69		221		0.90

Notes: The minimum bend radius is measured from the centerline of the hose.

Corrugated Metal Hose (Products)

PRESSUREFLEX

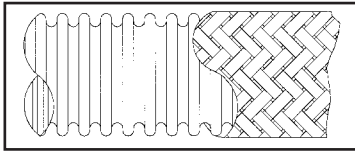

Pressureflex is Hose Master's high-pressure annular corrugated metal hose. With all the advantages of a hydroformed hose, Pressureflex is made from heavy wall T321 Stainless Steel. Pressureflex offers flexibility and dependability when higher pressures are a factor.

Explanation of **Pressureflex** Part Numbers:

AF 8 7

Braid
Code

Braid Codes

00 - Unbraided

50 - T304 Single Braid

55 - T304 Double Braid

*T316 Braid available upon request.

Example: AF8750 =
T321 Stainless Steel, annular,
corrugated metal hose with a
single T304 Stainless Steel Braid.

Inside Diameter (in.)	Number of Braids (#)	Outside Diameter (in.)	Static Min. Bend Radius (in.)	Dynamic Min. Bend Radius (in.)	Maximum Working Pressure (psi)	Burst Pressure (psi)	Weight Per Foot (lbs.)
3/4	0	1.13			45		0.32
	1	1.21	2.2	8.0	1142	4569	0.58
	2	1.29			1713	6854	0.84
1	0	1.44			45		0.38
	1	1.54	2.8	10.0	929	3717	0.74
	2	1.64			1394	5576	1.11
1 1/4	0	1.72			45		0.58
	1	1.82	3.1	11.0	766	3065	0.99
	2	1.92			1149	4598	1.40
1 1/2	0	2.05			28		0.75
	1	2.15	3.9	13.0	717	2866	1.29
	2	2.25			1075	4299	1.84
2	0	2.58			28		1.15
	1	2.70	5.1	15.0	649	2596	1.94
	2	2.82			974	3894	2.72
2 1/2	0	3.36			28		1.64
	1	3.48	6.9	17.0	507	2029	2.66
	2	3.60			761	3044	3.67
3	0	3.84			28		1.78
	1	3.96	7.9	20.0	369	1476	2.85
	2	4.08			554	2214	3.92
4	0	4.92			28		2.80
	1	5.04	9.8	25.0	330	1319	4.27
	2	5.16			495	1979	5.74
5*	0	5.96			28		3.03
	1	6.13	12.8	34.0	331	1324	5.14
6*	0	6.97			23		3.74
	1	7.22	14.8	40.0	285	1140	6.44

*Supplied with braided braid.

Notes: The minimum bend radius is measured from the centerline of the hose. The minimum bend radius increases with pressure (see chart on page 69). The working pressure decreases with temperature (obtain derating factor on page 67). For rapid pressure fluctuations consult the factory.

Call 1-800-221-2319
www.hosemaster.com



Corrugated Metal Hose (Products)

ChemKing®

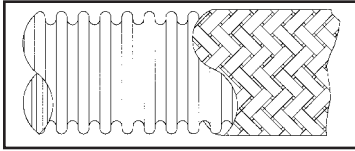

ChemKing® is Hose Master's chemical resistant annular corrugated metal hose. Hydroformed from a special 276 alloy, ChemKing® provides superior flexibility and excellent corrosion resistance. Used in a variety of industries, ChemKing® is the solution for many of the most severe chemical transfer applications.

Explanation of **ChemKing®** Part Numbers:

AF 6 7

Braid
Code

Braid Codes

00 - Unbraided

40 - T316 Single Braid

44 - T316 Double Braid

Example: AF6740 =

*276 annular, corrugated metal
hose with a single T316 Stainless
Steel Braid.*

Inside Diameter (in.)	Number of Braids (#)	Outside Diameter (in.)	Static Min. Bend Radius (in.)	Dynamic Min. Bend Radius (in.)	Maximum Working Pressure (psi)	Burst Pressure (psi)	Weight Per Foot (lbs.)
1/2	0	0.77	1.5	5.5	70	4743	0.11
	1	0.83			1186		0.22
	2	0.89			1779		0.33
3/4	0	1.16	2.1	8.0	43	3591	0.19
	1	1.22			898		0.37
	2	1.28			1347		0.55
1	0	1.47	2.7	9.0	43	2872	0.26
	1	1.53			718		0.50
	2	1.59			1077		0.74
1 1/2	0	2.08	3.9	11.0	28	2125	0.47
	1	2.16			531		0.85
	2	2.24			797		1.23
2	0	2.61	5.1	13.0	14	1797	0.59
	1	2.69			449		1.11
	2	2.77			674		1.63
3	0	3.88	7.8	18.0	14	1384	1.18
	1	3.98			346		2.06
	2	4.08			519		2.94
4*	0	4.96	9.8	22.0	14	1194	1.41
	1	5.06			299		2.47
	2	5.16			448		3.53
5*	0	6.00	12.8	28.0	14	1099	2.18
	1	6.12			275		3.61
	2	6.24			412		5.04
6*	0	7.01	14.8	32.0	11	839	2.69
	1	7.13			210		4.44
	2	7.25			315		6.19

* Consult factory for delivery.

Notes: The minimum bend radius is measured from the centerline of the hose. The minimum bend radius increases with pressure (see chart on page 69). The working pressure decreases with temperature (obtain derating factor on page 67). For rapid pressure fluctuations consult the factory.

Braid is T316 stainless steel. Monel braid is available upon request. When Monel braid is used, stated pressure ratings need to be reduced by 0.75. Part numbers for Monel braid are AF6780 (single braid), and AF6788 (double braid).

Corrugated Metal Hose (Products)

BRONZEFLEX

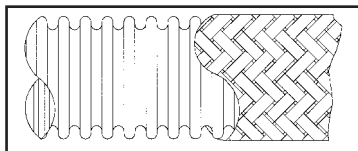

Bronzeflex is Hose Master's heavy-duty corrugated hose designed for use in those applications that specifically require bronze hose.

Explanation of **Bronzeflex** Part Numbers:

BF 11

Braid
Code

Braid Codes

- 00** - Unbraided
- 10** - Bronze Single Braid
- 11** - Bronze Double Braid

Example: BF1110 =
Bronze, annular, corrugated
metal hose with a single Bronze
Braid.

Inside Diameter (in.)	Number of Braids (#)	Outside Diameter (in.)	Static Min. Bend Radius (in.)	Dynamic Min. Bend Radius (in.)	Maximum Working Pressure (psi)	Burst Pressure (psi)	Weight Per Foot (lbs.)
3/8	0	0.63			60		0.18
	1	0.69	2.0	6.0	704	2816	0.31
	2	0.75			936	3744	0.44
1/2	0	0.77			50		0.23
	1	0.83	2.2	7.0	566	2264	0.43
	2	0.89			753	3012	0.63
3/4	0	1.13			30		0.47
	1	1.19	2.5	8.0	468	1872	0.81
	2	1.26			622	2488	1.15
1	0	1.42			26		0.56
	1	1.50	3.0	10.0	334	1336	0.97
	2	1.58			444	1776	1.38
1 1/4	0	1.81			16		0.79
	1	1.89	3.5	12.0	306	1224	1.34
	2	1.97			407	1628	1.69
1 1/2	0	2.13			15		1.04
	1	2.23	4.0	13.5	297	1188	1.74
	2	2.34			395	1580	2.44
2	0	2.64			10		1.15
	1	2.75	6.0	17.0	210	840	2.41
	2	2.85			279	1116	3.67
2 1/2	0	3.25			8		1.99
	1	3.37	8.5	22.0	194	776	3.33
	2	3.49			258	1032	4.67
3	0	3.70			5		2.68
	1	3.85	12.0	24.0	166	664	4.16
	2	3.95			221	884	5.64

Notes: The minimum bend radius is measured from the centerline of the hose. The minimum bend radius increases with pressure (see chart on page 69). The working pressure decreases with temperature (obtain derating factor on page 67). For rapid pressure fluctuations consult the factory.

Corrugated Metal Hose (Products)

EXTRAFLEX

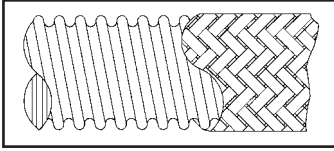

Extraflex is Hose Master's spirally-welded corrugated metal hose, specifically designed to maximize flexibility while maintaining good pressure ratings. The helical design facilitates draining and reduces in-line turbulence.

Explanation of **Extraflex** Part Numbers:

EF _____ 0 _____
Material Code Braid Code

Material Codes:
9 - T321 Stainless Steel
3 - T316L Stainless Steel

Braid Codes
00 - Unbraided
50 - T304 Single Braid
55 - T304 Double Braid
*T316 Braid available upon request.

Example: EF9050 =
T321 Stainless Steel, annular,
corrugated metal hose with a
single T304 Stainless Steel Braid.

Inside Diameter (in.)	Number of Braids (#)	Outside Diameter (in.)	Static Min. Bend Radius (in.)	Dynamic Min. Bend Radius (in.)	Maximum Working Pressure (psi)	Burst Pressure (psi)	Weight Per Foot (lbs.)
1/4	0	0.39			71		0.09
	1	0.45	0.4	2.2	1778	7112	0.13
	2	0.51			2489	9956	0.19
5/16	0	0.47			43		0.10
	1	0.53	0.6	2.4	1422	5688	0.18
	2	0.59			1991	7964	0.26
3/8	0	0.55			36		0.11
	1	0.61	0.6	2.8	1138	4552	0.19
	2	0.67			1707	6828	0.28
1/2	0	0.67			28		0.14
	1	0.73	0.8	3.1	910	3640	0.26
	2	0.79			1422	5688	0.39
5/8	0	0.85			28		0.19
	1	0.91	1.2	3.9	910	3640	0.32
	2	0.96			1422	5688	0.46
3/4	0	1.02			14		0.22
	1	1.08	1.4	5.1	711	2844	0.38
	2	1.18			1138	4552	0.55
1	0	1.22			11		0.26
	1	1.28	1.8	6.3	569	2276	0.54
	2	1.34			910	3640	0.83
1 1/4	0	1.57			9		0.45
	1	1.65	2.4	7.9	455	1820	0.76
	2	1.73			711	2844	1.09
1 1/2	0	1.89			7		0.65
	1	1.97	3.0	9.4	356	1424	1.02
	2	2.05			569	2276	1.40
2	0	2.36			6		0.71
	1	2.44	3.5	11.0	284	1136	1.22
	2	2.52			455	1820	1.75

Notes: The minimum bend radius is measured from the centerline of the hose. The minimum bend radius increases with pressure (see chart on page 70). The working pressure decreases with temperature (obtain derating factor on page 67). For rapid pressure fluctuations consult the factory.

Corrugated Metal Hose (Products)

HYDRAFLEX

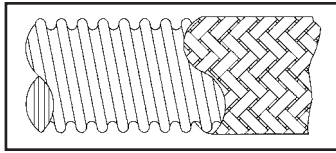

Hydrflex is Hose Master's T316 double-walled spirally-welded corrugated metal hose. Specially designed to maintain extreme pressure and flexibility, Hydrflex is self-draining and generates minimal in-line turbulence.

Explanation of **Hydrflex** Part Numbers:

HF 34

Braid
Code

Braid Codes

00 - Unbraided

50 - T304 Single Braid

55 - T304 Double Braid

*T316 Braid available upon request.

Example: HF3450 =

T316 Stainless Steel, helical,
corrugated metal hose with a
single T304 Stainless Steel Braid.

Inside Diameter (in.)	Number of Braids (#)	Outside Diameter (in.)	Static Min. Bend Radius (in.)	Dynamic Min. Bend Radius (in.)	Maximum Working Pressure (psi)	Burst Pressure (psi)	Weight Per Foot (lbs.)
1/4	1	0.52	1.1	5.0	4600	18400	0.21
	2	0.62			5800	23200	0.32
5/16	1	0.62	1.2	5.1	4000	16000	0.29
	2	0.74			4800	19200	0.45
3/8	1	0.70	1.4	5.5	3800	15200	0.36
	2	0.82			4000	16000	0.57
1/2	1	0.82	1.6	5.7	2600	10400	0.43
	2	0.94			3700	14800	0.69
5/8	1	0.97	2.2	6.1	2400	9600	0.51
	2	1.09			2700	10800	0.82
3/4	1	1.19	2.8	6.5	2000	8000	0.64
	2	1.31			2200	8800	1.03
1	1	1.39	3.5	7.9	1500	6000	0.78
	2	1.51			2000	8000	1.25
1 1/4	1	1.75	4.1	9.4	1100	4400	1.15
	2	1.87			1600	6400	1.70
1 1/2	1	2.07	5.1	12.2	1000	4000	1.45
	2	2.19			1500	6000	2.16
2	1	2.55	6.7	14.6	750	3000	1.97
	2	2.67			1100	4400	2.83

Notes: The minimum bend radius is measured from the centerline of the hose. The minimum bend radius increases with pressure (see chart on page 70). The working pressure decreases with temperature (obtain derating factor on page 67). For rapid pressure fluctuations consult the factory.

Corrugated Metal Hose (Specification by Diameter)

Hose Type and Inside Diameter (in.)	Number of Braids (#)	Static Minimum Bend Radius (in.)	Dynamic Minimum Bend Radius (in.)	Maximum Working Pressure (psi)
1/4"				
Annuflex available in T321, T316L, T304L Stainless Steel refer to page 15	0			90
	1	1.0	4.5	1800
	2			2700
Masterflex available in T321, T316L, T304L Stainless Steel refer to page 16	0			90
	1	0.9	3.7	1800
	2			2700
Formaflex available in T321 and T316L Stainless Steel refer to page 17	0	1.0	N/A*	90
	1			900
Extraflex available in T321 and T316L Stainless Steel refer to page 21	0			71
	1	0.4	2.2	1778
	2			2489
Hydraflex available in T316 Stainless Steel refer to page 22	1	1.1	5.0	4600
	2			5800
5/16"				
Extraflex available in T321 and T316L Stainless Steel refer to page 21	0			43
	1	0.6	2.4	1422
	2			1991
Hydraflex available in T316 Stainless Steel refer to page 22	1	1.2	5.1	4000
	2			4800
3/8"				
Annuflex available in T321, T316L, T304L Stainless Steel refer to page 15	0			70
	1	1.2	5.0	1558
	2			2336
Masterflex available in T321, T316L, T304L Stainless Steel refer to page 16	0			70
	1	1.0	4.0	1558
	2			2336
Formaflex available in T321 and T316L Stainless Steel refer to page 17	0	1.2	N/A*	70
	1			800
Bronzeflex Bronze corrugated metal hose refer to page 20	0			60
	1	2.0	6.0	704
	2			936
Extraflex available in T321 and T316L Stainless Steel refer to page 21	0			36
	1	0.6	2.8	1138
	2			1707
Hydraflex available in T316 Stainless Steel refer to page 22	1	1.4	5.5	3800
	2			4000

*N/A - non-applicable

Corrugated Metal Hose (Specification by Diameter)

Hose Type and Inside Diameter (in.)	Number of Braids (#)	Static Minimum Bend Radius (in.)	Dynamic Minimum Bend Radius (in.)	Maximum Working Pressure (psi)
1/2"				
Annuflex available in T321, T316L, T304L Stainless Steel refer to page 15	0			70
	1	1.5	5.5	1186
	2			1779
Masterflex available in T321, T316L, T304L Stainless Steel refer to page 16	0			70
	1	1.2	4.4	1186
	2			1779
Formaflex available in T321 and T316L Stainless Steel refer to page 17	0	1.5	N/A*	70
	1			665
ChemKing® available in 276 refer to page 19	0			70
	1	1.5	5.5	1186
	2			1779
Bronzeflex Bronze corrugated metal hose refer to page 20	0			50
	1	2.2	7.0	566
	2			753
Extraflex available in T321 and T316L Stainless Steel refer to page 21	0			28
	1	0.8	3.1	910
	2			1422
Hydraflex available in T316 Stainless Steel refer to page 22	1			2600
	2	1.6	5.7	3700
5/8"				
Annuflex available in T321, T316L, T304L Stainless Steel refer to page 15	0			57
	1	1.8	7.0	1205
	2			1808
Masterflex available in T321, T316L, T304L Stainless Steel refer to page 16	0			57
	1	1.4	5.6	1205
	2			1808
Formaflex available in T321 and T316L Stainless Steel refer to page 17	0	1.8	N/A*	57
	1			500
Extraflex available in T321 and T316L Stainless Steel refer to page 21	0			21
	1	1.2	3.9	910
	2			1422
Hydraflex available in T316 Stainless Steel refer to page 22	1			2400
	2	2.2	6.1	2700

*N/A - non-applicable

Corrugated Metal Hose (Specification by Diameter)

Hose Type and Inside Diameter (in.)	Number of Braids (#)	Static Minimum Bend Radius (in.)	Dynamic Minimum Bend Radius (in.)	Maximum Working Pressure (psi)
3/4"				
Annuflex available in T321, T316L, T304L Stainless Steel refer to page 15	0			43
	1	2.1	8.0	898
	2			1347
Masterflex available in T321, T316L, T304L Stainless Steel refer to page 16	0			43
	1	1.7	6.4	898
	2			1347
Formaflex available in T321 and T316L Stainless Steel refer to page 17	0	2.1	N/A*	43
	1			380
Pressureflex available in T321 Stainless Steel refer to page 18	0			45
	1	2.2	8.0	1142
	2			1713
ChemKing® available in 276 refer to page 19	0			43
	1	2.1	8.0	898
	2			1347
Bronzeflex Bronze corrugated metal hose refer to page 20	0			30
	1	2.5	8.0	468
	2			622
Extraflex available in T321 and T316L Stainless Steel refer to page 21	0			14
	1	1.4	5.1	711
	2			1138
Hydraflex available in T316 Stainless Steel refer to page 22	1	2.8	6.5	2000
	2			2200
1"				
Annuflex available in T321, T316L, T304L Stainless Steel refer to page 15	0			43
	1	2.7	9.0	718
	2			1077
Masterflex available in T321, T316L, T304L Stainless Steel refer to page 16	0			43
	1	2.1	7.1	718
	2			1077
Formaflex available in T321 and T316L Stainless Steel refer to page 17	0	2.7	N/A*	43
	1			355
Pressureflex available in T321 Stainless Steel refer to page 18	0			45
	1	2.8	10.0	929
	2			1394
ChemKing® available in 276 refer to page 19	0			43
	1	2.7	9.0	718
	2			1077
Bronzeflex Bronze corrugated metal hose refer to page 20	0			26
	1	3.0	10.0	334
	2			444
Extraflex available in T321 and T316L Stainless Steel refer to page 21	0			11
	1	1.8	6.3	569
	2			910
Hydraflex available in T316 Stainless Steel refer to page 22	1	3.5	7.9	1500
	2			2000

*N/A - non-applicable

Corrugated Metal Hose (Specification by Diameter)

Hose Type and Inside Diameter (in.)	Number of Braids (#)	Static Minimum Bend Radius (in.)	Dynamic Minimum Bend Radius (in.)	Maximum Working Pressure (psi)
1 1/4"				
Annuflex available in T321, T316L, T304L Stainless Steel refer to page 15	0			43
	1	3.1	10.0	645
	2			968
Masterflex available in T321, T316L, T304L Stainless Steel refer to page 16	0			43
	1	2.5	7.9	645
	2			968
Formaflex available in T321 and T316L Stainless Steel refer to page 17	0	3.1	N/A*	43
	1			280
Pressureflex available in T321 Stainless Steel refer to page 18	0			45
	1	3.1	11.0	766
	2			1149
Bronzeflex Bronze corrugated metal hose refer to page 20	0			16
	1	3.5	12.0	306
	2			407
Extraflex available in T321 and T316L Stainless Steel refer to page 21	0			9
	1	2.4	7.9	455
	2			711
Hydraflex available in T316 Stainless Steel refer to page 22	1	4.1	9.4	1100
	2			1600
1 1/2"				
Annuflex available in T321, T316L, T304L Stainless Steel refer to page 15	0			28
	1	3.9	11.0	531
	2			797
Masterflex available in T321, T316L, T304L Stainless Steel refer to page 16	0			28
	1	3.1	8.7	531
	2			797
Formaflex available in T321 and T316L Stainless Steel refer to page 17	0	3.9	N/A*	28
	1			264
Pressureflex available in T321 Stainless Steel refer to page 18	0			28
	1	3.9	13.0	717
	2			1075
ChemKing® available in 276 refer to page 19	0			28
	1	3.9	11.0	531
	2			797
Bronzeflex Bronze corrugated metal hose refer to page 20	0			15
	1	4.0	13.5	297
	2			395
Extraflex available in T321 and T316L Stainless Steel refer to page 21	0			7
	1	3.0	9.4	356
	2			569
Hydraflex available in T316 Stainless Steel refer to page 22	1	5.1	12.2	1000
	2			1500

•N/A - non-applicable

Call 1-800-221-2319
www.hosemaster.com



Corrugated Metal Hose (Specification by Diameter)

Hose Type and Inside Diameter (in.)	Number of Braids (#)	Static Minimum Bend Radius (in.)	Dynamic Minimum Bend Radius (in.)	Maximum Working Pressure (psi)
2"				
<i>Annuflex</i> available in T321, T316L, T304L Stainless Steel refer to page 15	0			14
	1	5.1	13.0	449
	2			674
<i>Masterflex</i> available in T321, T316L, T304L Stainless Steel refer to page 16	0			14
	1	4.0	10.3	449
	2			674
<i>Formaflex</i> available in T321 and T316L Stainless Steel refer to page 17	0	5.1	N/A*	14
	1			221
<i>Pressureflex</i> available in T321 Stainless Steel refer to page 18	0			28
	1	5.1	15.0	649
	2			974
<i>ChemKing®</i> available in 276 refer to page 19	0			14
	1	5.1	13.0	449
	2			674
<i>Bronzeflex</i> Bronze corrugated metal hose refer to page 20	0			10
	1	6.0	17.0	210
	2			279
<i>Extraflex</i> available in T321 and T316L Stainless Steel refer to page 21	0			6
	1	3.5	11.0	284
	2			455
<i>Hydraflex</i> available in T316 Stainless Steel refer to page 22	1			750
	2	6.7	14.6	1100
2 1/2"				
<i>Annuflex</i> available in T321, T316L, T304L Stainless Steel refer to page 15	0			14
	1	6.8	16.0	417
	2			626
<i>Masterflex</i> available in T321, T316L, T304L Stainless Steel refer to page 16	0			14
	1	5.4	12.8	417
	2			626
<i>Pressureflex</i> available in T321 Stainless Steel refer to page 18	0			28
	1	6.9	17.0	507
	2			761
<i>Bronzeflex</i> Bronze corrugated metal hose refer to page 20	0			8
	1	8.5	22.0	194
	2			258
3"				
<i>Annuflex</i> available in T321, T316L, T304L Stainless Steel refer to page 15	0			14
	1	7.8	18.0	346
	2			519
<i>Masterflex</i> available in T321, T316L, T304L Stainless Steel refer to page 16	0			14
	1	6.3	14.5	346
	2			519
<i>Pressureflex</i> available in T321 Stainless Steel refer to page 18	0			28
	1	7.9	20.0	369
	2			554
<i>ChemKing®</i> available in 276 refer to page 19	0			14
	1	7.8	18.0	346
	2			519
<i>Bronzeflex</i> Bronze corrugated metal hose refer to page 20	0			5
	1	12.0	24.0	166
	2			221

*N/A - non-applicable

Corrugated Metal Hose (Specification by Diameter)

Hose Type and Inside Diameter (in.)	Number of Braids (#)	Static Minimum Bend Radius (in.)	Dynamic Minimum Bend Radius (in.)	Maximum Working Pressure (psi)
4"				
<i>Annuflex</i> available in T321, T316L, T304L Stainless Steel refer to page 15	0			14
	1	9.8	22.0	299
	2			448
<i>Masterflex</i> available in T321, T316L, T304L Stainless Steel refer to page 16	0			14
	1	7.7	17.4	299
	2			448
<i>Pressureflex</i> available in T321 Stainless Steel refer to page 18	0			28
	1	9.8	25.0	330
	2			495
<i>ChemKing®</i> available in 276 refer to page 19	0			14
	1	9.8	22.0	299
	2			448
5"				
<i>Annuflex</i> available in T321, T316L, T304L Stainless Steel refer to page 15	0			14
	1	12.8	28.0	275
	2			412
<i>Masterflex</i> available in T321, T316L, T304L Stainless Steel refer to page 16	0			14
	1	10.0	21.9	275
	2			412
<i>Pressureflex</i> available in T321 Stainless Steel refer to page 18	0			28
	1	12.8	34.0	331
	2			
<i>ChemKing®</i> available in 276 refer to page 19	0			14
	1	12.8	28.0	275
	2			412
6"				
<i>Annuflex</i> available in T321, T316L, T304L Stainless Steel refer to page 15	0			11
	1	14.8	32.0	210
	2			315
<i>Masterflex</i> available in T321, T316L, T304L Stainless Steel refer to page 16	0			11
	1	11.6	25.0	210
	2			315
<i>Pressureflex</i> available in T321 Stainless Steel refer to page 18	0			23
	1	14.8	40.0	285
	2			
<i>ChemKing®</i> available in 276 refer to page 19	0			11
	1	14.8	32.0	210
	2			315
8"				
<i>Annuflex</i> available in T321, T316L, T304L Stainless Steel refer to page 15	0			3
	1	20.0	40.0	212
10"				
<i>Annuflex</i> available in T321, T316L, T304L Stainless Steel refer to page 15	0			2
	1	25.0	50.0	175
12"				
<i>Annuflex</i> available in T321, T316L, T304L Stainless Steel refer to page 15	0			2
	1	30.0	60.0	160

•N/A - non-applicable

Corrugated Metal Hose (Fittings)



Metal hose is more versatile than other hose in that virtually any fitting can be attached to metal hose. Other types of hose require special shanks and collars in order to attach fittings. For metal hose, any fitting made from a weldable material can be attached without the need for special features. This versatility also means that multiple fittings can be welded together to make custom solutions for difficult applications.

Selecting the proper fittings for an application is largely determined by the mating fittings to which the hose assembly will be attached. Once the mating fittings have been identified, the hose fittings should complement the mating fittings in type, size, and alloy. Even though the selection of hose fittings is determined by the mating fittings, it is a good idea to confirm that the fittings used in the application are appropriate for the application and any necessary changes made. Ensure that the fittings are chemically compatible with and are able to withstand the pressure and temperatures of both the media and the surrounding environment.

The following pages show commonly used fittings for corrugated metal hose assemblies.

Please contact Hose Master's Customer Service Department for end connections that are not listed.



Male Pipe Nipple

- **Alloys** - T304 and T316 Stainless Steel, Carbon Steel, 276
- **Sizes** - 1/8" thru 8"
- **Schedules** - 40 and 80



Hex Male

- **Alloys** - T304 and T316 Stainless Steel, Carbon Steel, Brass
- **Sizes** - 1/4" thru 4"



Victaulic Fitting

- **Alloys** - T304 and T316 Stainless Steel, Carbon Steel
- **Sizes** - 1" thru 8"
- **Schedule** - 40

Corrugated Metal Hose (Fittings)



LiveLink® Swivel Fitting

- **Alloys** - T304 Stainless Steel
- **Sizes** - 1/4" thru 2"



Female Union (Threaded/Socket Weld)

- **Alloys** - T304 and T316 Stainless Steel, Carbon Steel, Malleable Iron, Brass
- **Sizes** - 1/4" thru 4"
- **Class** - 125#, 150#, 3000# (Carbon Steel Only)



Female Half Coupling (Threaded/Socket Weld)

- **Alloys** - T304 and T316 Stainless Steel, Carbon Steel
- **Sizes** - 1/4" thru 4"
- **Class** - 150#, 3000#



1, 2, or 3 Piece SAE (JIC)

- **Alloys** - T316 Stainless Steel, Carbon Steel, Brass (nut only)
- **Sizes** - 1/4" thru 2"



45° and 90° SAE (JIC)

- **Alloys** - Stainless Steel, Carbon Steel
- **Sizes** - 1/2" thru 2"

Corrugated Metal Hose (Fittings)



Sanitary Flange

- **Alloys** - T304 and T316 Stainless Steel
- **Sizes** - 1" thru 3"



Slip-on Flange

- **Alloys** - T304 and T316 Stainless Steel, Carbon Steel
- **Sizes** - 1/2" thru 12"
- **Class** - 150#, 300#



Plate Flange

- **Alloys** - T304 and T316 Stainless Steel, Carbon Steel
- **Sizes** - 1/2" thru 12"
- **Class** - 150#



Weld Neck Flange

- **Alloys** - T304 and T316 Stainless Steel, Carbon Steel
- **Sizes** - 1/2" thru 6"
- **Class** - 150#, 300#



TTMA Flange

- **Alloys** - T316 Stainless Steel, Carbon Steel
- **Sizes** - 2" thru 6"

Corrugated Metal Hose (Fittings)



C Stub with Floating Flange

- **Alloys** - T304 and T316 Stainless Steel
- **Sizes** - 1/2" thru 10"
- **Schedule** - 10



A Stub with Lap Joint Flange

- **Alloys** - T304 and T316 Stainless Steel, Carbon Steel, 276
- **Sizes** - 1/2" thru 8"
- **Schedules** - 10, 40



TTMA C Stub Swivel

- **Alloys** - T304 and T316 Stainless Steel
- **Sizes** - 4" thru 6"
- **Schedule** - 10



Part A and Part D (Cam-Lock)

- **Alloys** - T316 Stainless Steel, Brass, Aluminum
- **Sizes** - 1/2" thru 8"



Tube End

- **Alloys** - T304, T316, and T321 Stainless Steel, Carbon Steel
- **Sizes** - 1/8" thru 8" (seamless and welded)
- **Wall Thickness** - Various

Corrugated Metal Hose (Fittings)



Short and Long Radius Elbows (45° and 90°)

- **Alloys** - T304 and T316 Stainless Steel, Carbon Steel, 276
- **Sizes** - 1/4" thru 6"



Reducer

- **Alloys** - T304 and T316 Stainless Steel, Carbon Steel
- **Sizes** - 3/4" thru 6"
- **Schedule** - 10, 40 (Carbon Steel)



Beveled Pipe End

- **Alloys** - T304 and T316 Stainless Steel, Carbon Steel, 276
- **Sizes** - 1/8" thru 8"
- **Schedules** - Various



Ground Joint Female

- **Alloys** - Carbon Steel
- **Sizes** - 1/2" thru 4"



Specialty Gas Nuts

- **Alloys** - Brass
- **Sizes** - A, B, C, D
- **Thread Type** - SAE and BSP

Corrugated Metal Hose (Length)

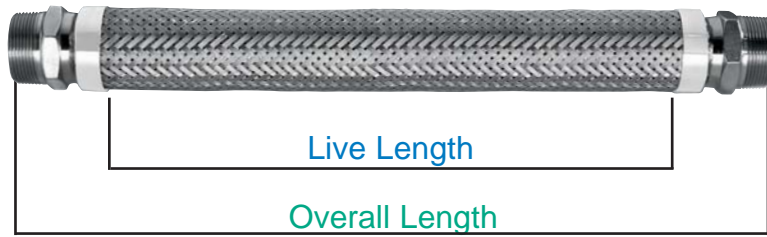

To calculate the proper length of a hose assembly:

- **Verify that the installation is properly designed** – Page 72 illustrates the right and wrong ways to install a hose assembly. Basically, there are three considerations:
 1. Do not torque the hose.
 2. Do not overbend the hose.
 3. Do not compress the hose.
- **Calculate the live length of the assembly** – The live length of the assembly is the amount of active (flexible) hose in an assembly; that is, the hose between the braided collars. Pages 73 - 75 give formulas to calculate live length for a variety of common hose installations.
- **Calculate the overall length of the assembly** – Overall length is equal to the live length plus the lengths of the braided collars and fittings. When adding fitting lengths be aware that the points from which measurements should be taken vary for different fitting types. When calculating overall length for assemblies with threaded fittings, remember to account for the length of thread that is lost by threading into the mating connection (see Thread Allowance chart on page 72).

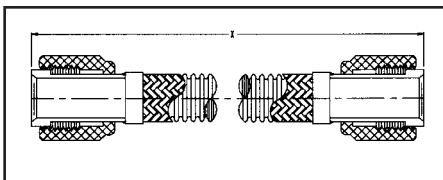

JIC/SAE type fittings are measured from the seat of the fitting.

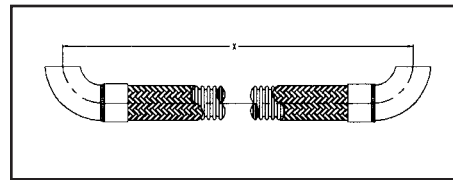

Elbows and other fittings with a radius are measured from the centerline of the fitting.

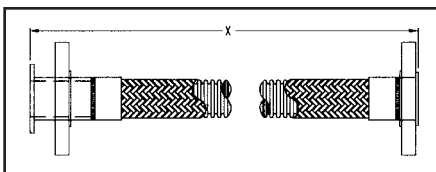

Flanges are measured from the flange face or from the face of the stub end if one is used.

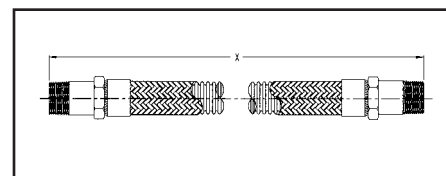

Threaded fittings are measured to the end of the fitting.

For assistance in making any calculation or for dimensional information on fittings, please contact Hose Master's Customer Service Department.

Corrugated Metal Hose (Fabrication Options)



Corrugated metal hose is used in a very broad spectrum of applications. Just as the hose, fittings, and other assembly parts must be tailored to suit the demands of the service, so must the methods of joining these components. While standard production joining methods work very well for the majority of service demands, the following extremes may dictate special joining or fabrication techniques:

- Pressures
- Temperatures
- Corrosion
- Other conditions

Hose Master has developed specialized welding, brazing, joining, and fabrication procedures to assure the integrity and serviceability of metal hose assemblies in even the most extreme applications.

The fabrication options to be considered are:

- A. Specialized attachment techniques
- B. Testing options
- C. Additional cleaning requirements
- D. Packaging

In each of the following sections, the standard method and available options are explained. Select the options best suited for your application.

Corrugated Metal Hose (Fabrication Options)

A. Specialized Attachment Techniques:

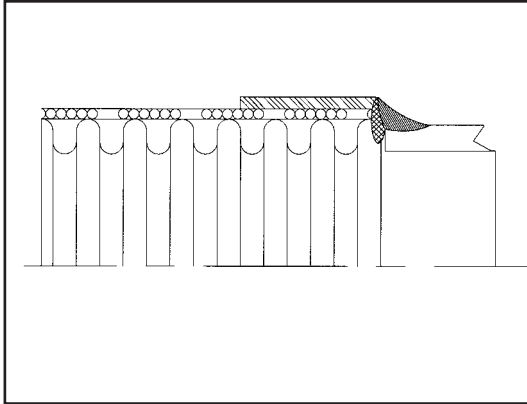

Industry Standard - This method will be used unless another method is specified.

Standard fabrication of an assembly generally consists of:

- Cutting the hose and braid through a hose corrugation valley.
- Installation of a braid collar over each end of the hose.
- Trimming of any excess braid.
- “Cap” welding the hose, braid, and braid collar together.
- Cleaning the cap weld surface.
- Placement and alignment of a fitting on the cap weld.
- “Attachment” welding the fitting to the cap weld.
- Silver brazing is also available. Consult factory.

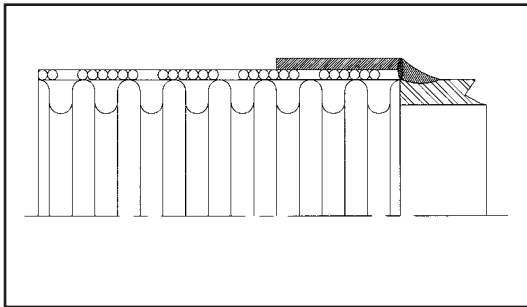

Half-Corrugation - Standard fabrication sometimes leaves a portion of the cut corrugation, or corrugation “lip”, just under the base of the fitting. In specialized applications this residual lip may not be desirable. To prevent any exposed corrugation edges from causing damage, the hose can be specially prepared for welding by cutting the corrugation on the crest, rather than in the valley, thereby removing the lip.

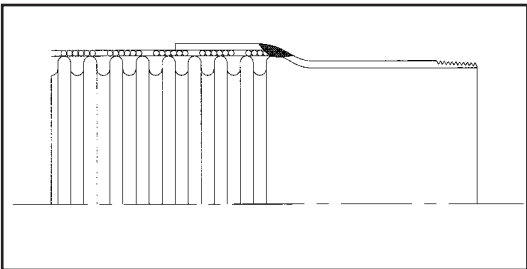

Smooth Transition Weld - For applications in which corrosion is a concern, all crevices and fissures must be minimized. Specialized hose and fitting preparation, in conjunction with proprietary welding techniques, is available to provide a full penetration hose-to-fitting weld that is smooth and crevice free.

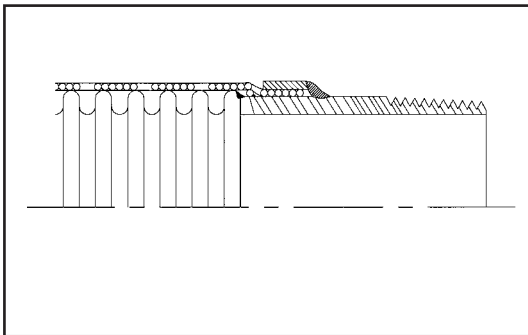

Braid-Over Construction - Assemblies operating at the upper limits of their rated working pressure or in severe service may benefit from a braid-over construction. The fitting is first welded to the unbraided hose. Then a special metal reinforcing ring is installed over the fitting and next to the weld. Finally the braid is drawn over the end of the hose and the ring, and welded to the side of the fitting. This technique reduces the amount of heat introduced into the braid wires, nearly eliminates the heat effected zones of the cap and attachment welds, and maximizes the wire strength. Braid-over construction may also be used for specific high cycle applications.

Corrugated Metal Hose (Fabrication Options)

B. Testing Options:



Standard Leak Testing - Every corrugated hose assembly is leak tested prior to shipment. Standard testing consists of pressurizing the assembly with air and then submerging the entire assembly under water. This method is reliable and sufficient for the majority of applications.



Hydrostatic Testing - While the standard test is designed to detect leaks, hydrostatic testing is designed to test the assembly's strength. Testing of an assembly to its full permissible test pressure can be economically and accurately accomplished by filling the assembly with liquid while concurrently evacuating all air. The assembly is then hydrostatically pressurized using high pressure pumps. The test pressure is maintained for a predetermined period of time.



High Pressure Gas - Testing with air under water, at pressures of up to 2500 psi, is available for specialized applications. For a more sensitive test, the use of gases such as nitrogen or helium can be requested.



Dye Penetrant - Dye penetrant testing is available for both leak and for weld bead inspection, in accordance with Hose Master procedures or to customer specified standards.



Helium Mass Spectrometer - This is the most sensitive leak detection method generally available. The standard test method is to attach the assembly to a mass spectrometer and generate a very high vacuum in the assembly. The exterior of the assembly is then flooded with helium. The relatively tiny helium atoms penetrate even very small openings and are drawn into the mass spectrometer where they are detected and the leak size quantified. Helium Mass Spectrometer testing can be modified to satisfy customer or regulatory agency requirements.

Note: Always test an assembly with a medium that has a smaller molecular or atomic size than the service required.

Corrugated Metal Hose (Fabrication Options)

C. Additional Cleaning Requirements:



The hydroforming method of corrugated hose manufacturing inherently yields a very clean product. However, specialized cleaning for specific applications is available upon request. Contact Hose Master's Customer Service Department for details.

D. Packaging:



All assemblies are shipped with protectors over sealing surfaces such as threads and flange faces. Spacer bars are installed on all shorter double-flanged assemblies to prevent compression of the assembly during shipping and handling. Special packaging is available to suit customer requirements, including crating, plastic bagging, labeling, and custom fitting protectors.

Corrugated Metal Hose (Accessories)

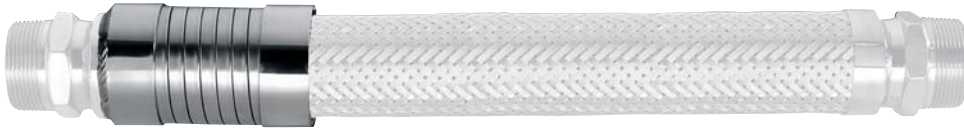

Metal hose assemblies often require special accessories or components in order to provide long service life in severe applications or make the assemblies easier to use. There are many accessories that may be specified including:

- Guard, made from metal and other materials, can be provided to protect an assembly from overbending, abrasion, impact, and thermal damage.
- Jacket and tracer hoses are incorporated into corrugated hose assemblies in order to keep certain media at elevated or reduced temperatures so that it can be easily conveyed.
- A sacrificial bronze braid can be inserted between the hose and the stainless steel braid to improve cycle life.

One or several accessories can be easily combined with an assembly to more efficiently transport media, protect the assembly, or both.

The following pages list some common accessories along with a brief explanation of the benefits each accessory offers. This is not an exhaustive list of all possible accessories. Please contact Hose Master's Customer Service Department with your specific requirements.



Spring Guard - When there is potential for damaging an assembly in service, a guard can be easily installed during fabrication. This type of guard consists of a metal spring that is attached behind the fitting. The style of guard can be tailored to meet the application and the type of hose.

Corrugated Metal Hose (Accessories)



Protective Cover - If the potential for impact or high temperature damage is not severe, or if the additional weight and bulk of a full metal guard is unacceptable, rubber or plastic scuff guards can be installed to protect the corrugated hose and braid.



Insulating Jackets - If the corrugated hose is to convey hot media, and there is a potential for skin contact, an insulated, protective jacket is available. The jacket consists of a tubular braided fiberglass insulation, covered and impregnated with silicone rubber. The jacket is installed over the corrugated hose and metal banded in place. The jacket can also be used to insulate the corrugated assembly and either prevent ambient heat from being conveyed to the media or to reduce heat loss.



Tagging - A variety of tags and identifications can be affixed to assemblies. These include cardboard, plastic, and metal tags. Serial numbers, application information, assembly performance capabilities, and other customer specific information can be provided either on tags or permanently engraved onto one or both braid collars.

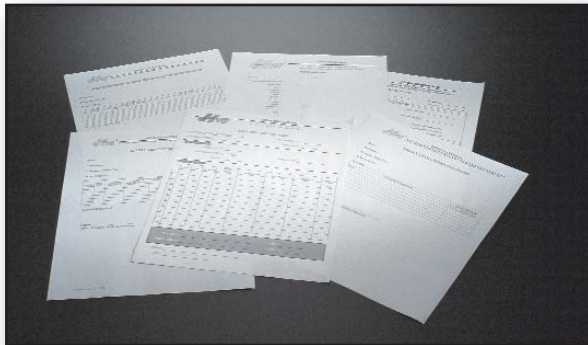

Certifications - Standard written certifications for materials or inspections can be supplied for corrugated hose or assemblies. Certifications of conformance to specific customer requirements such as military certifications are also available.

Corrugated Metal Hose (Accessories)

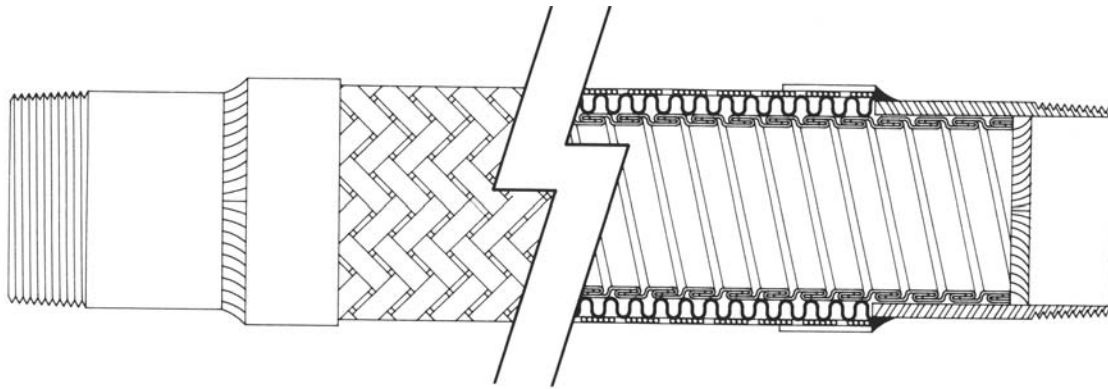

Liners - An interlocked hose or liner is often installed inside a corrugated hose assembly. The liner commonly serves two additional purposes, while still maintaining the full working pressure of the corrugated hose. The first is to protect the hose corrugations from excessive media velocities. Media speeds can induce resonant vibrations in the corrugations causing rapid fatigue and subsequent fracturing of the hose wall (see page 67 for recommended flow velocities). The liner provides a relatively smooth surface for the media and, by avoiding the media impacting on the corrugation valleys, reduces the chances of harmonic resonance. The second purpose for a liner is for abrasion resistance. Even slightly abrasive media flowing at medium to high speeds can cause premature wear of the corrugated hose interior surfaces. The liner provides a smooth flow path as well as a relatively thick layer of abrasion resistant metal between the media and the corrugated hose. The liner will also help reduce pressure loss due to friction between the media and corrugated hose. Proper fit between the hoses is essential for good performance. Because Hose Master makes both the corrugated hose and liners, perfect fit is assured.

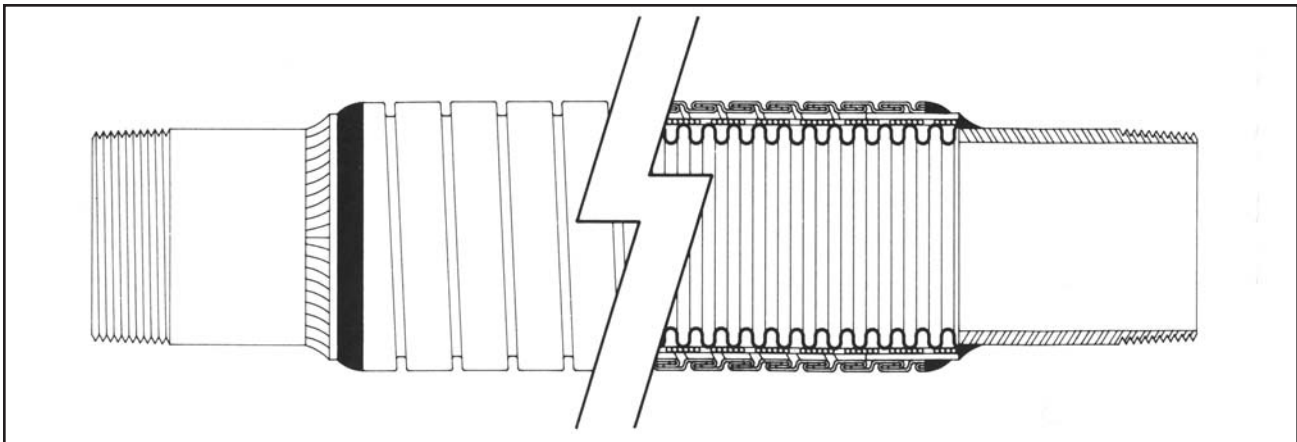

Armor Guard / Bend Restrictor - Applications in which the corrugated hose is subject to external abrasion, molten material splash, or impact damage may require a protective armor or guard along all or a portion of its length. A guard is typically made from interlocked or squarelocked metal hose and is welded to the assembly. Note that the bend restrictor has a bend diameter equal to or greater than the corrugated hose it is protecting.

Corrugated Metal Hose (Accessories)

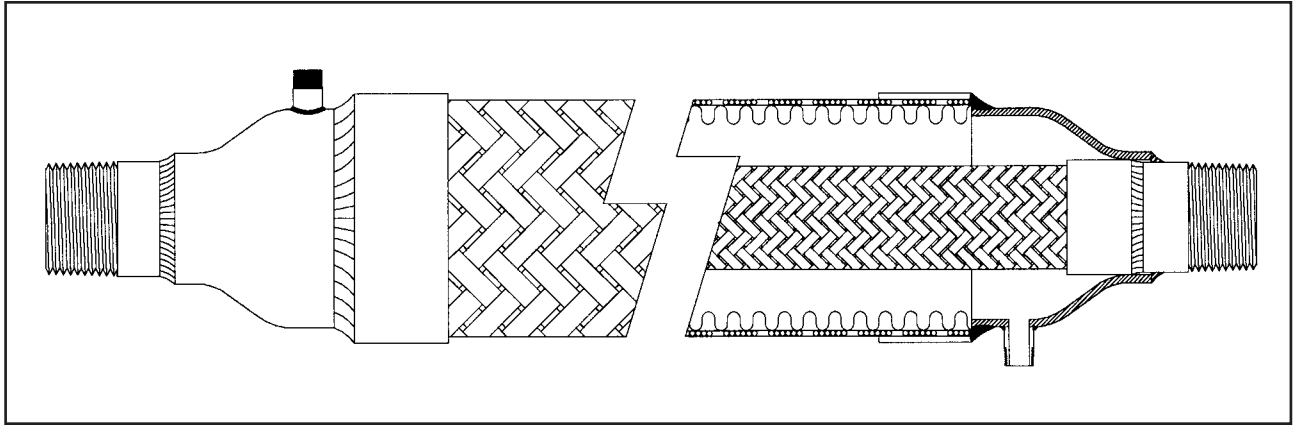

Jacketed Assemblies - A jacketed assembly consists of a “hose within a hose.” An inner or primary media conveying hose is enclosed or jacketed by a larger diameter hose. The hoses are joined at each end by specially designed fittings so that there is no media pathway between the two hoses. Jacketed assemblies are often specified when the primary media must be kept at either an elevated or cryogenic temperature. Steam is often circulated through the jacket hose to keep a viscous material in the inner hose hot and easily conveyed. A vacuum can also be pulled on the jacket hose to insulate cryogenic liquids being conveyed in the inner hose.

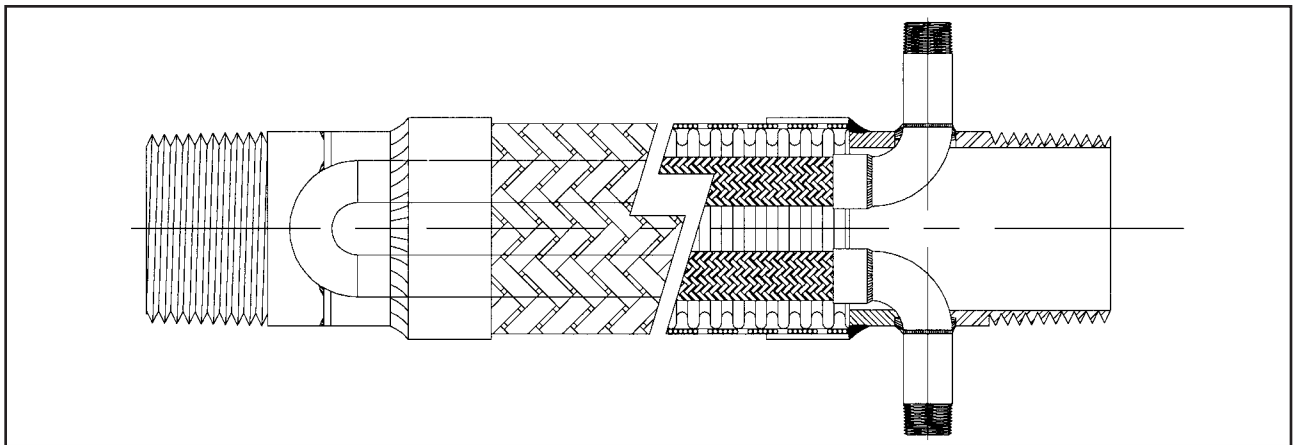

Tracers - Traced assemblies are similar in concept to jacketed assemblies in that there is an inner, smaller diameter hose encased by a single larger diameter hose. Where jacketed assemblies surround the media with heat or cold, traced assemblies have the media surround the hose containing the heating or cooling element. The tracer, or inner hose, may also be installed in a long “U” shaped loop within the outer hose, with the steam inlet and outlet at the same end of the assembly.

Stripwound Metal Hose (Designing an Assembly)



Care should be taken when specifying a stripwound hose assembly. Each of the components can have a dramatic effect on the assembly's performance. In addition to carefully selecting components, the way they are assembled is also very important. Hose Master has developed fabrication techniques that help maximize the assembly's performance. Two of these techniques are square cutting the hose ends and welding on the inside of the fittings.



The stripwound profile is helical. When it is cut by traditional methods, the hose end will also be helical. This creates a gap between the fitting and the end of the hose. This gap can cause the fittings to separate from the hose during use. Square cutting ensures that the hose end and the fitting are flush, leaving no gaps.



If the fittings are welded on the hose, welding the inside provides for a smooth transition between hose and fittings, preventing product from becoming damaged.

Specifying a Stripwound Hose Assembly:

Designing a stripwound hose assembly requires the determination of five factors:

1. Hose (type, alloy, and size): page 45
2. End fittings (type, alloy, and size for each end): page 51
3. Assembly length: page 54
4. Fabrication options: page 55
5. Accessories: page 57

If these factors have been determined, a fabricator will be able to make the assembly. If not, these questions may be answered by proceeding to the next section, *Analyzing an Application*.

Analyzing an Application:

S.T.A.M.P.E.D.

To properly design a metal hose assembly for a particular application, the following design parameters must be determined. To help remember them, they have been arranged to form the acronym “S.T.A.M.P.E.D.”

1. **S**ize – The diameter of the connections in which the assembly will be installed is needed to provide a proper fit. This information is required.
2. **T**emperature – As the temperature to which the assembly is exposed (internally and externally) increases, the strength of the assembly’s components decreases. If you do not provide this information it will be assumed that the temperatures are 70°F.
3. **A**pplication – This refers to the configuration in which the assembly is installed. This includes the dimensions into which the assembly must fit as well as the details of any movement that the assembly will experience. This is required since you cannot determine the proper length or proper hose type without it.
4. **M**edia – Identify all chemicals to which the assembly will be exposed, both internally and externally. This is important since you must be sure that the assembly’s components are chemically compatible with the media. If no media is given it will be assumed that both the media and environment are compatible with all of the available materials for each component.
5. **P**ressure – Identify the internal pressure to which the assembly will be exposed. Stripwound metal hose, by the nature of its construction, is not pressure tight. However, pressure and media infiltration through the stripwound wall can be minimized by the insertion of one of a variety of packings into the wall during hose manufacturing. If no pressure is given it will be assumed that there is no pressure.
6. **E**nd Fittings – Identify the necessary fittings. This is required since fittings for the assembly must be chosen to properly fit the mating connections.
7. **D**ynamics – Identify the velocity of the media flowing through the assembly. Extremely high flow or abrasive media can cause premature failure. If no velocity is given, it will be assumed that the velocity is not fast enough to affect the assembly’s performance.

To make gathering this information easier, Hose Master has provided a convenient worksheet to help select components on page 78.

Stripwound Metal Hose (Hose)



As the name suggests, stripwound hose is made from a strip of steel that is profiled and continuously wound around a mandrel to form a hose. Hose Master's proprietary manufacturing process yields an extremely consistent and balanced profile, maximizing strength and flexibility. There are four different types of stripwound hose:

1. **Roughbore Interlocked** - The strip is formed with legs that interlock to form a tighter, more rugged construction.

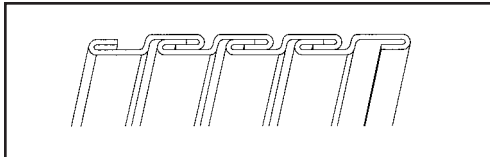

Extremely flexible. Ideally suited for conveying dry, bulk materials, for open-end gas exhaust, and as a protective cover.

2. **Smoothbore Interlocked** - Made by adding another steel strip inside a roughbore hose to provide a smooth surface, thereby reducing damage to sensitive materials.

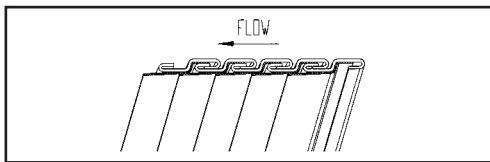

Extremely flexible. Ideally suited for dry bulk conveying.

3. **Packed Interlocked** - Packing may be added to interlocked hose to minimize leakage through the hose profile.

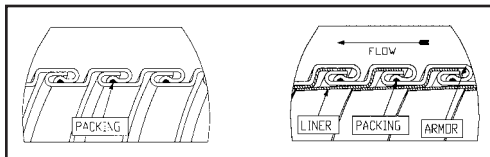

The most effective packings are made from resilient materials such as elastomers and, to a lesser extent, cotton. Harder materials (stainless steel and copper) are also available if required.

4. **Squarelocked** - The strip is formed into square shapes that are locked together.

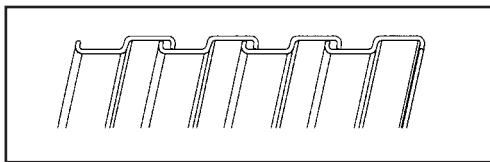

Extremely flexible. Primarily used as a protective covering for wires, fiberoptic cables, and other hoses.

Selecting a Hose:

When selecting a stripwound hose, you should first decide the most appropriate type of hose (squarelocked, interlocked, smoothbore interlocked). Then, of the options that are available, select the one best suited for the application. Choose the most compatible alloy for the service and environment in which the hose will be installed. Then, based on your requirements, choose a strip thickness. The thicker the steel strip, the better the hose is suited for heavier duty. Finally, determine if you need packing and, if so, which packing best suits your application.

Stripwound Metal Hose (Products)

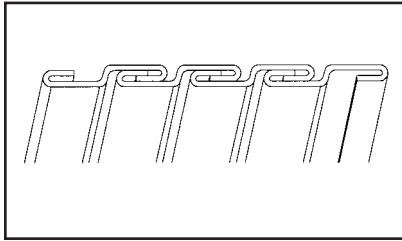

Interflex is a high-quality, general-purpose, roughbore interlocked metal hose formed from a single metal strip. Hose Master's balanced interlocking process provides maximum flexibility and the longest service life47

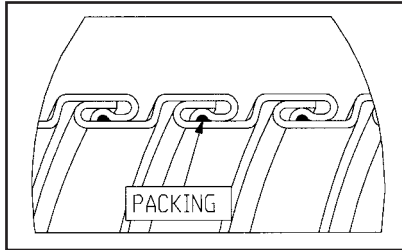

Tar and Asphalt is a sturdy, leak resistant, flexible interlocked metal hose used for the transfer of high temperature viscous fluids. Tar and Asphalt hose is constructed from a high grade, heavy gauge galvanized steel with Hose Master's proprietary packing. Tar and Asphalt hose ensures maximum suction and is design tested to 100 psi48

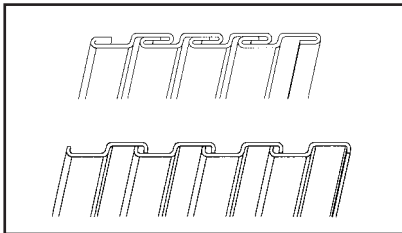

FloppyGuard™ is Hose Master's line of small-bore, stripwound, metal hose. Used for armor or casing applications, FloppyGuard™ offers superior flexibility and crush resistant construction49

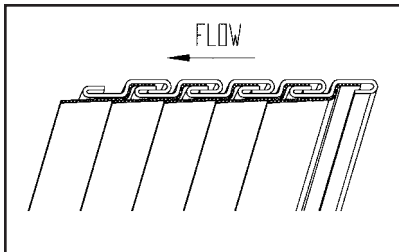

Ultraflex is a smoothbore metal hose ideally suited for dry bulk pneumatic conveyance. This hose is produced with a durable armor and a highly abrasion-resistant liner. Hose Master's precision manufacturing process makes Ultraflex unequalled in strength and flexibility50

Note: Product specifications are subject to change.

Stripwound Metal Hose (Products)

INTERFLEX

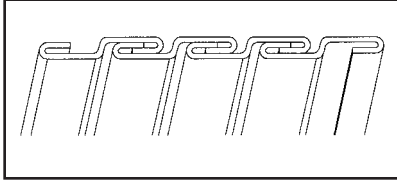

Interflex is Hose Master's general-purpose interlocked metal hose which is used to convey air, exhaust, and a variety of solid materials. (Interflex hose should not be used with products that can be damaged when conveyed through a roughbore hose.) It is constructed from a single strip of metal that is profiled and locked onto itself. The interlocked, or overlapping, sections of strip are able to slide back and forth, thus providing the ability to flex.

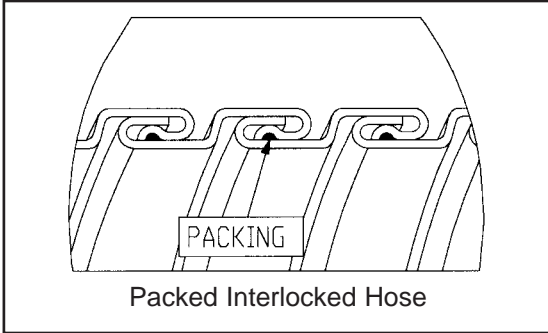

Explanation of **Interflex** Part Numbers:

IN _____	
Strip Thickness	Material Code
Strip Thicknesses:	
10 - Extra Light Weight	Material Codes:
15 - Light Weight	AL - Aluminum
18 - Medium Weight	GS - Galvanized Steel
20 - Medium Weight (Aluminum only)	SS - Stainless Steel (Consult Factory)
25 - Heavy Weight	
30 - Extra Heavy Weight	

Inside Diam. (in.)	IN 10 GS or SS		IN 15 GS or SS		IN 18 GS or SS		IN 25 GS or SS		IN 30 GS Only		IN 20 AL Only	
	Wt. Per Ft. (lbs.)	Min. Bend Radius (in.)	Wt. Per Ft. (lbs.)	Min. Bend Radius (in.)	Wt. Per Ft. (lbs.)	Min. Bend Radius (in.)	Wt. Per Ft. (lbs.)	Min. Bend Radius (in.)	Wt. Per Ft. (lbs.)	Min. Bend Radius (in.)	Wt. Per Ft. (lbs.)	Min. Bend Radius (in.)
1 1/2	0.5	6	0.7	7	0.9	7	1.3	8				
2	0.7	8	1.0	9	1.1	9	1.7	10	2.0	11		
2 1/2	0.8	10	1.2	11	1.4	11	2.1	12	2.5	13		
3	1.0	11	1.4	12	1.6	13	2.5	15	2.9	15	0.7	15
3 1/2	1.1	13	1.6	14	1.9	15	2.8	17	3.4	18	0.8	17
4	1.2	15	1.8	16	2.2	17	3.2	19	3.8	20	0.9	19
4 1/2	1.4	17	2.0	18	2.4	19	3.6	21	4.3	22	1.0	21
5	1.5	19	2.2	20	2.7	21	4.0	24	4.7	25	1.1	24
6	1.8	22	2.7	24	3.2	25	4.7	28	5.6	29	1.3	28
7			3.1	28	3.7	30	5.5	33	6.5	34	1.5	33
8			3.5	32	4.2	34	6.2	37	7.4	39	1.8	37
9			3.9	35	4.7	38	7.0	42	8.3	43	2.0	42
10			4.4	39	5.2	42	7.7	46	9.2	48	2.2	46
11					5.7	46	8.5	51	10.1	53	2.4	51
12					6.2	50	9.3	55	11.0	57	2.6	55
13					6.7	54	10.0	60	11.9	62	2.8	60
14					7.2	58	10.8	64	12.8	67	3.0	64
15					7.7	62	11.5	69	13.7	71	3.2	69
16					8.2	66	12.3	73	14.6	76	3.4	73

Notes: Other diameters are available upon request. For packed hose add 10% to both weight per foot and minimum bend radius. Minimum bend radius is measured from the centerline of the hose.

Available Packings		
Packing Type	Features	Max Temp.
Low-Temp Elastomeric	Max Pressure and Vacuum	200°
High-Temp Elastomeric	Max Pressure and Vacuum	400°
Low-Temp Fiber	Economical	180°
High-Temp Fiber	High-Temp. Filament	1000°
Metal	Extreme Temp.	800° - 1200°

When to Consider Packing:

Interlocked metal hose, by the nature of its construction, is not pressure tight. However, pressure and media infiltration through the interlocked wall can be minimized by the insertion of one of a variety of packings into the wall during hose manufacturing. Packing consists of a continuous cord or strand of elastomer, or other material which is locked into a special channel between the interlocked hose wall layers. The choice of packing material is tailored to the demands of the specific application.

 Call 1-800-221-2319
www.hosemaster.com

Stripwound Metal Hose (Products)

TAR & ASPHALT

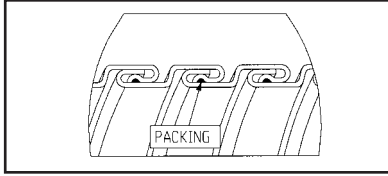

Tar and Asphalt is Hose Master's heavy-weight interlocked metal hose. Constructed from a single strip of galvanized steel with Hose Master's proprietary packing, this hose is ideal for transferring high-temperature viscous fluids. Tar and Asphalt hose is leak resistant and handles maximum suction. It is design tested to 100 psi and has a temperature range of -40° F to 500° F.

Explanation of **Tar and Asphalt** Part Numbers:

TA 30 GS
 Strip Material
 Thickness Code

Strip Thicknesses:

30 - Extra Heavy Weight

Material Codes:

GS - Galvanized Steel

Diameter (inches)	Minimum Bend Radius (inches)	Weight Per Foot (lbs.)
1 1/2	9	1.8
2	12	2.2
2 1/2	15	2.8
3	17	3.2
4	22	4.2

Notes: Other diameters are available upon request. Minimum bend radius is measured from the centerline of the hose.

TAR & ASPHALT FITTINGS



Heavy duty packed-on reusable rigid male or female swivel fittings can be attached upon request. Please refer to page 53 for fitting details.

Stripwound Metal Hose (Products)

FloppyGuard™



FloppyGuard™ is Hose Master's line of floppy-interlocked metal hose. Constructed from a variety of alloys, this product offers superior flexibility and crush-resistant construction. Used in a wide range of applications, including casing or armor for small diameter hose and electrical cable, FloppyGuard™ is available in sizes from 3/16" I.D. and up, and can be covered with PVC or fluoropolymer coatings for liquid-tight or chemically-resistant service. All FloppyGuard™ is ultrasonically cleaned prior to packaging. Because of Hose Master's ability to design and make its own tooling, Hose Master can custom design FloppyGuard™ to meet your exact specifications. Please contact Hose Master's Customer Service Department with your specific requirements.

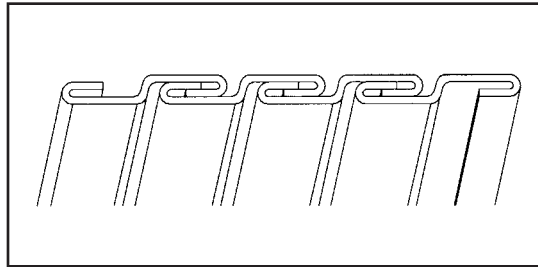

Interlocked Design (SB)

FloppyGuard SQ™ is Hose Master's line of squarelocked stripwound hose. It can be used in a wide variety of applications where fully interlocked construction is not required. It is excellent for use as shielding on electrical wiring and fiberoptic cable. FloppyGuard SQ™ is available in sizes ranging from 1/8" to 5/8" I.D., and can be covered with PVC or fluoropolymer coatings for liquid-tight or chemically-resistant service.

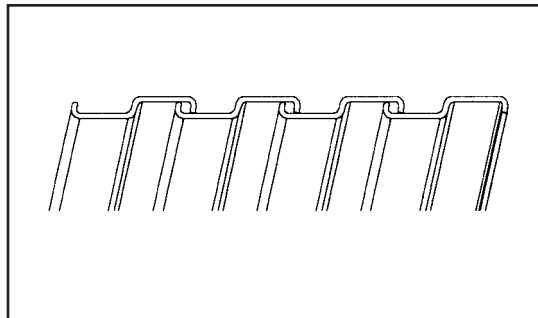

Squarelocked Design (SQ)

Stripwound Metal Hose (Products)

ULTRAFLEX

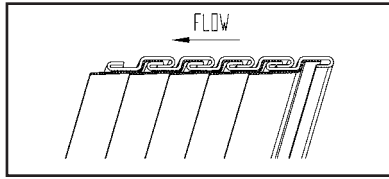

Ultraflex is Hose Master's smoothbore lined hose. It is constructed from two strips of metal that form a durable armored hose and a smooth, abrasion-resistant metal liner (see drawing). The liner protects the product being conveyed from damage that can be caused by a rough interior. Ultraflex is ideal for pneumatic and dry bulk conveying. A directional arrow on the hose indicates flow direction for optimum performance.

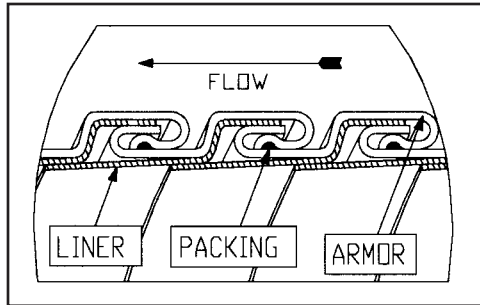

Explanation of **Ultraflex** Part Numbers:

UF		
Armor Material	Armor Strip	Liner Material
Armor Materials:	Armor Strips:	Liner Materials:
A - Aluminum	15 - Light Weight	S - Stainless Steel
G - Galvanized Steel	18 - Medium Weight	(consult Factory)
S - Stainless Steel	20 - Medium Weight	C - Carbon Steel
(Consult Factory)	(AL only)	
	25 - Heavy Weight	

Inside Diam. (in.)	UF (G/S) 15 (C/S)		UF (G/S) 18 (C/S)		UF (G/S) 25 (C/S)		UFA 20 (C/S)	
	Wt. Per Ft. (lbs.)	Min Bend Radius (in.)	Wt. Per Ft. (lbs.)	Min. Bend Radius (in.)	Wt. Per Ft. (lbs.)	Min. Bend Radius (in.)	Wt. Per Ft. (lbs.)	Min. Bend Radius (in.)
1 1/2	1.2	7	1.3	8				
2	1.6	9	1.7	10				
2 1/2	1.9	11	2.2	12				
3	2.3	13	2.6	14	3.2	18		
3 1/2	2.6	15	3.0	16	3.7	21		
4	3.0	17	3.4	18	4.2	23	2.1	23
4 1/2	3.4	19	3.8	21	4.7	26	2.3	26
5	3.7	21	4.2	23	5.2	29	2.6	29
6	4.5	25	5.0	27	6.2	34	3.1	34
7	5.2	29	5.8	32	7.2	40	3.6	40
8	5.9	33	6.6	36	8.2	45	4.1	45
9	6.6	37	7.4	40	9.2	51	4.6	51
10	7.4	40	8.2	45	10.2	56	5.1	56
11			9.0	49	11.2	62		
12			9.8	53	12.2	67		
13			10.6	58	13.2	73		
14			11.4	62	14.2	78		
15			12.2	66	15.2	84		
16			13.1	71	16.2	89		

Notes: Other diameters are available upon request. For packed hose add 10% to both weight per foot and minimum bend radius. Minimum bend radius is measured from the centerline of the hose.

When to Consider Packing:

Interlocked metal hose, by the nature of its construction, is not pressure tight. However, pressure and media infiltration through the interlocked wall can be minimized by the insertion of one of a variety of packings into the wall during hose manufacturing. Packing consists of a continuous cord or strand of elastomer, or other material which is locked into a special channel between the interlocked hose wall layers. The choice of packing material is tailored to the demands of the specific application.

Available Packings		
Packing Type	Features	Max Temp.
Low-Temp Elastomeric	Max Pressure and Vacuum	200°
High-Temp Elastomeric	Max Pressure and Vacuum	400°
Low-Temp Fiber	Economical	180°
High-Temp Fiber	High-Temp. Filament	1000°
Metal	Extreme Temp.	800° - 1200°

Call 1-800-221-2319
www.hosemaster.com



Stripwound Metal Hose (Fittings)



Selecting the proper fittings for an application is largely determined by the mating fittings to which the hose assembly will be attached. Once the mating fittings have been identified, the hose fittings should complement the mating fittings in type, size and alloy. Even though the selection of hose fittings is determined by the mating fittings, it is a good idea to confirm that the fittings used in the application are appropriate for the application and any necessary changes made. Ensure that the fittings are chemically compatible with and are able to withstand the conditions in which the hose is installed and in which it will be used.

The following pages show commonly used fittings for stripwound hose.

Please contact Hose Master's Customer Service Department for end connections that have not been listed.



Male Pipe Nipple

- **Alloys** - T304 and T316 Stainless Steel, Carbon Steel, Aluminum
- **Sizes** - 1 1/2" thru 8"
- **Schedules** - 40, 80



Victaulic Fitting

- **Alloys** - T304 and T316 Stainless Steel, Carbon Steel
- **Sizes** - 1 1/2" thru 8"

Stripwound Metal Hose (Fittings)



Slip-on Flange

- **Alloys** - T304 and T316 Stainless Steel, Carbon Steel
- **Sizes** - 1 1/2" thru 12"
- **Class** - 150#, 300#



Plate Flange

- **Alloys** - T304 and T316 Stainless Steel, Carbon Steel
- **Sizes** - 1 1/2" thru 14"
- **Class** - 150#



C Stub with Floating Flange

- **Alloys** - T304 and T316 Stainless Steel
- **Sizes** - 1 1/2" thru 10"
- **Schedule** - 10



Part A and Part D (Cam-Lock)

- **Alloys** - T316 Stainless Steel, Carbon Steel, Aluminum
- **Sizes** - 1 1/2" thru 8"



Tube End

- **Alloys** - T304 and T316 Stainless Steel, Carbon Steel, Aluminum
- **Sizes** - 1 1/2" thru 8"
- **Wall Thickness** - Various

Stripwound Metal Hose (Fittings)



Reducer

- **Alloys** - T304 and T316 Stainless Steel, Carbon Steel
- **Sizes** - 1 1/2" thru 6"
- **Schedule** - 10, 40 (Carbon Steel)



Beveled Pipe End

- **Alloys** - T304 and T316 Stainless Steel, Carbon Steel, Aluminum
- **Sizes** - 1 1/2" thru 8"
- **Schedules** - Various



NPSH Female or Male

- **Alloys** - T304 Stainless Steel
- **Sizes** - 4" thru 6"



Tar and Asphalt Male and Female

- **Alloys** - Malleable Iron
- **Sizes** - 1 1/2" thru 4"



Compensator

- **Alloys** - Urethane
- **Sizes** - 3" thru 6"

Stripwound Metal Hose (Length)

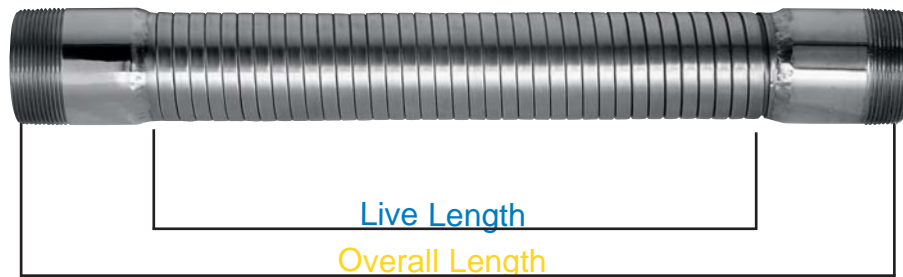

To calculate the proper length of a hose assembly you should follow these steps:

- **Verify that the installation is properly designed for the hose assembly** – Page 72 illustrates the right and wrong ways to install a hose assembly. Basically, there are two considerations:
 1. Do not torque the hose.
 2. Do not overbend the hose.
- **Calculate the live length of the assembly** – The live length of the assembly is the amount of active (flexible) hose in an assembly; that is, the length of hose between the fittings. Pages 73 - 75 give formulas to calculate live length for a variety of common hose installations.
- **Calculate the overall length of the assembly** – Overall length is equal to the live length plus the lengths of the fittings. When adding fitting lengths be aware that the points from which measurements should be taken vary for different fitting types. When calculating overall length for assemblies with threaded fittings, remember to account for the length of thread that is lost by threading into the mating connection (see Thread Allowance chart on page 72).

Because of its design, stripwound hose may be fully extended, fully compressed, or any state between the two. The length difference between fully compressed and fully extended may be as great as 30%. Stripwound hose performs best at the midpoint between fully compressed and fully extended, so bear this in mind when specifying length.

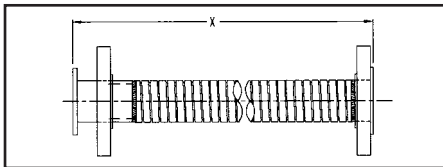

Flanges are measured from the flange face or, if used, from the face of the stub end.

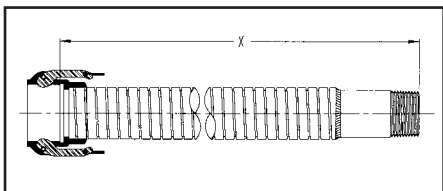

Threaded fittings are measured to the end of the fitting. Female cam and groove fittings are measured from the seat of the fitting.

For assistance in making any calculation or for dimensional information on fittings, please contact Hose Master's Customer Service Department.

Call 1-800-221-2319
www.hosemaster.com



Stripwound Metal Hose (Fabrication Options)



Interlocked metal hose is used in a variety of applications. Just as the hose, fittings, and other assembly parts must be tailored to suit the demands of the service, so must the methods of joining these components. Hose Master has developed specialized fabrication procedures to assure the integrity and serviceability of metal hose assemblies in even the most extreme applications.

The attachment options to be considered are:

1. Epoxy
2. Welding/Brazing
3. I.D./O.D. Welding
4. Mechanical Attachment

The following page identifies each of these methods and gives a brief explanation under what circumstances each should be considered.

Stripwound Metal Hose (Fabrication Options)

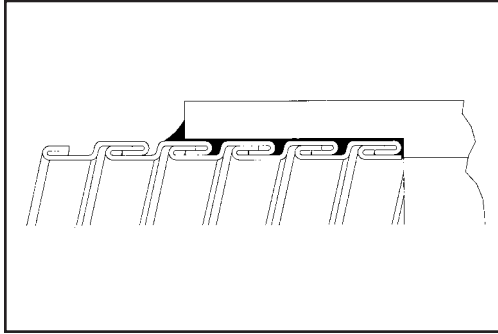

Epoxy - Fittings may be attached to interlocked hose using a 2-part epoxy. An epoxied fitting-to-hose connection, made with properly prepared fittings, can be as strong or stronger than the hose itself at service temperatures up to 200°F. Epoxy is recommended for packed interlocked hose to avoid damaging the packing material. Epoxy also affords a convenient method for field attachment of a variety of fittings to interlocked hose.

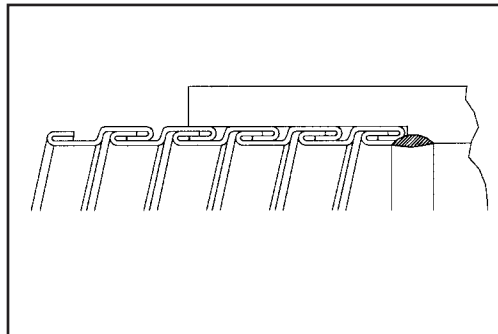

Welding/Brazing - Welding provides the strongest possible connection between the hose and fittings. Whenever possible, the weld is made on the interior, or I.D., hose-to-fitting joint in order to provide a smooth surface over which the media flows. Welding is generally not recommended for packed interlocked hose, as the packing may be damaged by the high welding temperature.

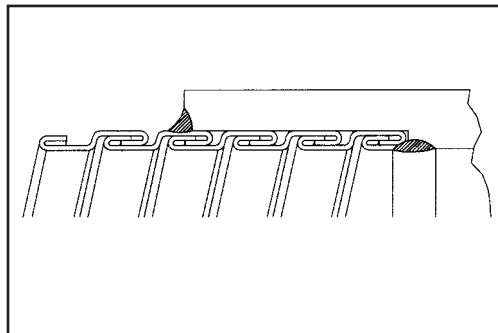

I.D./O.D. - If the fittings are welded to the hose, welding the I.D. provides for a smooth transition between hose and fittings, preventing product from becoming damaged. Also, welding the O.D. of the fitting prevents exterior contamination from entering the crevice while providing additional strength.

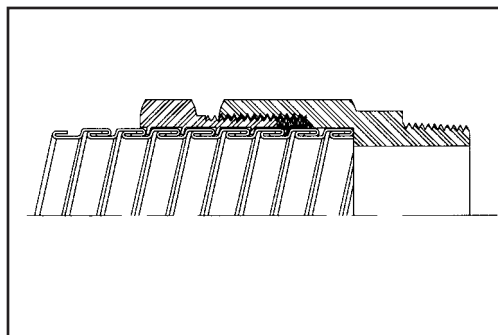

Mechanical Attachment - Certain high temperature applications requiring interlock hose, particularly Tar and Asphalt service, require a fitting that actually threads and locks onto the hose corrugations. A high temperature packing is used to seal against leakage. These fittings are leak tight up to 400°F and are easily field attached.

Stripwound Metal Hose (Accessories)



Stripwound hose assemblies often require special accessories or components. Accessories may be used to improve performance or to make the assembly easier to use.

The following pages list some common accessories along with a brief explanation of the benefits each accessory offers. This is not an exhaustive list of all possible accessories. Please contact Hose Master's Customer Service Department if you would like an accessory not listed.



Lay Line - A straight, painted line can be applied to interlocked hose along its entire length. This lay line serves to give clear warning to the user if the hose is being potentially damaged from torque or twisting in service. Monitoring torsion or twisting of the assembly can significantly increase the service life of the hose.



Flow Arrows - Smoothbore interlocked hose is unidirectional in that the overlapping liner strip affords a smooth surface in one direction. Media flow in the opposite direction can easily cause damage to both the hose and to abrasion sensitive media, such as plastic pellets. Flow arrows are painted on all smoothbore hose to indicate the correct flow direction. In specific high-velocity applications, the flow direction can also become a factor in roughbore interlock hose. Flow arrows can be provided on roughbore hose upon customer request.

Stripwound Metal Hose (Accessories)



Square Cutting - If the hose service requires a smooth transition from the hose to the fittings, the end of the hose must fit flush against the fitting shoulder. The only way to provide this kind of fit between hose and fitting is to square cut the end of the hose.



Braid - For higher than normal working pressures, or for critical safety situations, a stainless steel braid can be installed and welded over a stripwound hose assembly. The braid serves to prevent the hose from overextending and damaging the hose wall.



Tagging - A variety of tags (metal, plastic, or cardboard) is readily available to record hose identification, service information, or any customer specific information.

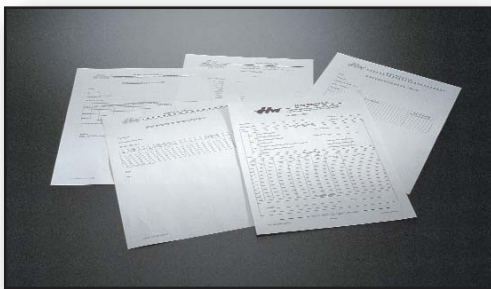

Certifications - Standard written certifications for materials or inspections can be supplied for stripwound hose or assemblies. Certifications of conformance to specific customer requirements are also available.

Technical Information (Table of Contents)

Definitions60
Geometric Formulas65
Conversions66
Temperature Derating67
Velocity in Metal Hose67
Minimum Bend Radius Charts68
Vibration71
Do's and Don'ts72
Thread Allowance72
Length Calculations73
Pressure Drop76
Saturated Steam77
Thermal Expansion of Pipe77
Metal Hose Specification Sheet78

Technical Information (Definitions)

ABRASION

External damage to a hose assembly caused by its being rubbed on a foreign object.

AMBIENT/ATMOSPHERIC CONDITIONS

The surrounding conditions, such as temperature, pressure, and corrosion, to which a hose assembly is exposed.

AMPLITUDE OF VIBRATIONS AND/OR LATERAL MOVEMENT

The distance a hose assembly deflects laterally to one side from its normal position, or when this deflection occurs on both sides of the normal hose centerline.

ANCHOR

A restraint applied to eliminate motion and restrain forces.

ANGULAR DISPLACEMENT

Displacement of two parts defined by an angle.

ANNULAR

Refers to the convolutions on a hose that are a series of complete circles or rings located at right angles to the longitudinal axis of the hose (sometimes referred to as "bellows").

APPLICATION

The service conditions that determine how a metal hose assembly will be used.

ARMOR OR CASING

Flexible interlocked or squarelocked tubing placed over the entire length or in short lengths at the end of a metal hose to protect it from physical damage and to limit the bending radius.

ATTACHMENT

The method of fixing end fittings to flexible metal hose, i.e., welding, brazing, soldering, swaging, bonding, or mechanical.

AXIAL MOVEMENT

Compression or elongation along the longitudinal axis.

BASKET WEAVE

A braid pattern in which the strands of wire alternately cross over and under two strands (two over-two under).

BEND RADIUS

The radius of a bend measured to the hose centerline, as recommended by the manufacturer.

BEND RADIUS, DYNAMIC

The radius at which constant or continuous flexing occurs.

BEND RADIUS, INTERMITTENT

The radius used for non-continuous operation.

BEND RADIUS, MINIMUM

The smallest radius at which a hose can be used.

BEND RADIUS, STATIC

The smallest fixed radius at which a hose can be subjected.

BRAID

A flexible wire sheath surrounding a metal hose that prevents the hose from elongation due to internal pressure. Braid is composed of a number of wires wrapped helically around the hose while at the same time going under and over each other in a basket weave fashion.

BRAID ANGLE

The acute angle formed by the braid strands and the axis of the hose.

BRAID MAKE UP

Term applies to description of braid, e.g. 32-12-.015, T321 SS, where: 32 is the number of carriers; 12 is the number of wires on each carrier; .015 is the wire diameter in inches; and T321 SS is the material, Type 321 stainless steel.

BRAID SLEEVE/RING/FERRULE/COLLAR

A ring made from tube or metal strip placed over the ends of a braided hose to contain the braid wires for attachment of fitting and ferrule, and to immobilize heat affected corrugations.

BRAID WEAR

Motion between the braid and corrugated hose which normally causes wear on the outside diameter of the corrugation and the inside diameter of the braid.

Call 1-800-221-2319
www.hosemaster.com



Technical Information (Definitions)

BRAIDED BRAID

In this braid, the strands of wire on each carrier of the braiding machine are braided together, and then braided in normal fashion, hence the term braided braid.

BRAZING

A process of joining metals using a non-ferrous filler metal having a melting point that is lower than the "parent metals" to be joined.

BUTT WELD

A process in which the edges or ends of metal sections are butted together and joined by welding.

CASING (See ARMOR)

CONTROLLED FLEXING

Occurs when the hose is being flexed regularly, as in the case of connections to moving components. Examples: platen presses and thermal growth in pipe work.

CONVOLUTION/CORRUGATION

The annular or helical flexing member in corrugated or stripwound hose/corrugation.

CORROSION

The chemical or electro-chemical attack of a media upon a hose assembly.

CYCLE-MOTION

The movement from normal to extreme position and return.

DEVELOPED LENGTH/OVERALL LENGTH

The length of a hose plus fittings required to meet the conditions of a specific application.

DIAMOND WEAVE

A braid pattern in which the strands alternately cross over one and under one of the strands (one over - one under). Also known as "plain weave."

DYE PENETRANT INSPECTION/TEST

A non-destructive inspection method for detecting surface defects.

DISPLACEMENT

The amount of motion applied to a hose defined in inches for parallel offset and degrees for angular misalignment.

DOG-LEG ASSEMBLY

Two hose assemblies joined by a common elbow.

DUPLEX ASSEMBLY

An assembly consisting of two hose assemblies - one inside the other, and connected at the ends. Also known as "jacketed assemblies."

EFFECTIVE THRUST AREA HOSE

The cross-sectional area described by the mean diameter of the hose.

ELASTIC/INTERMITTENT FLEXURE

The smallest radius that a given hose can be bent without permanent deformation to the metal in its flexing members (convolutions or corrugations).

EROSION

The wearing away of the inside or outside convolutions of a hose caused by the flow of the media conveyed, such as wet steam, abrasive particles, etc.

FATIGUE FAILURE

Failure of the metal structure associated with, or due to the flexing of metal hose or bellows.

FERRULE (See BRAID SLEEVE)

FITTING/COUPLING

A loose term applied to the nipple, flange, union, etc., attached to the end of a metal hose.

FLOW RATE

Pertains to a volume of media being conveyed in a given time period, e.g., cubic feet per hour, pounds per second, gallons per minute, etc.

FLUID

A gas or liquid medium.

FREQUENCY

The rate of vibration or flexure of a hose in a given time period, e.g. cycles per second (CPS), cycles per minute (CPM), cycles per day (CPD).

Technical Information (Definitions)

GALVANIC-CORROSION

Corrosion that occurs on the less noble of two dissimilar metals in direct contact with each other in an electrolyte, such as water, sodium chloride in solution, sulfuric acid, etc.

GMAW

Gas Metal Arc Weld.

GTAW (See TIG WELD/GTAW)

GUIDE (For PIPING)

A device that supports a pipe radially in all directions, but directs movement.

HELICAL

Used to describe a type of corrugated hose having one continuous convolution resembling a screw thread.

HELICAL WIRE ARMOR/SPRING GUARD

To provide additional protection against abrasion. Metal hoses can be supplied with an external round or oval section wire spiral.

INSIDE DIAMETER (I.D.)

The diameter inside of the hose corrugation.

INSTALLATION

The installed geometry of a hose assembly.

INTERLOCKED/SQUARELOCKED HOSE

Formed from profiled strip and wound into flexible metal tubing with no subsequent welding, brazing, or soldering. May be made pressure-tight by winding in strands of packing.

LAP WELD (LW)

Type of weld in which the ends or edges of the metal overlap each other.

LINER

Flexible sleeve used to line the inside diameter of hose when conveying a high velocity media, also prevents erosion.

LIVE LENGTH

The amount of active (flexible) length of hose in an assembly. Does not include the length of fittings and ferrules.

LOOP INSTALLATION

The assembly is installed in a loop or "U" shape and is most often used when frequent and/or large amounts of motion are involved.

MEAN DIAMETER

The midpoint between the inside diameter and the outside diameter of a corrugated hose.

MECHANICAL FITTING/REUSABLE FITTING

A fitting attached to a hose which can be disassembled and used again.

MEDIUM, MEDIA

The substance(s) being conveyed through a system.

MISALIGNMENT

A condition where two parts do not meet true.

NOMINAL DIAMETER

Indicates the approximate inside diameter.

OFFSET-LATERAL, PARALLEL

The distance that the ends of a hose assembly are displaced in relation to each other as a result of connecting two misaligned terminations in a system, or intermittent flexure required in a hose application.

OPERATING CONDITIONS

The pressure, temperature, motion, and environment to which a hose assembly is subjected.

OUTSIDE DIAMETER (O.D.)

The external diameter of a metal hose, measured at the top of the corrugation or braiding.

PENETRATION (WELD)

The percentage of wall thickness of the two parts to be joined that is fused into the weld pool in making a joint.

PERCENT OF BRAID COVERAGE

The percent of the surface area of a hose that is covered by braid.

Call 1-800-221-2319
www.hosemaster.com



Technical Information (Definitions)

PITCH

The distance between the two peaks of adjacent corrugations or convolutions.

PLY, PLIES

The number of individual thicknesses of metal used in the construction of a wall of the convoluted hose.

PRESSURE

Usually expressed in pounds per square inch (psi).

PRESSURE, ABSOLUTE (PSIA)

A total pressure measurement system in which atmospheric pressure at sea level is added to the gauge pressure.

PRESSURE, ATMOSPHERIC

The pressure of the atmosphere at sea level which is 14.7 psi, or 29.92 inches of mercury.

PRESSURE, BURST (ACTUAL)

Failure of the hose determined by the laboratory test in which the braid fails in tensile, or the hose ruptures, or both, due to the internal pressure applied. This test is usually conducted at room temperature with the assembly in a straight line, but for special applications, can be conducted at elevated temperatures and various configurations.

PRESSURE, BURST (RATED)

A burst value which may be theoretical, or a percentage of the actual burst pressure developed by a laboratory test. It is expected that, infrequently, due to manufacturing limitations, an assembly may burst at this pressure, but would most often burst at a pressure greater than this.

PRESSURE, DEFORMATION

The pressure at which the convolutions of a hose become permanently deformed.

PRESSURE, FEET OF WATER OR HEAD

Often used to express system pressure in terms of water column height. A column of water 1 foot high exerts a .434 psi pressure at its base.

PRESSURE, MAXIMUM ALLOWABLE WORKING

The maximum pressure at which a hose or hose assembly is designed to be used.

PRESSURE, MAXIMUM TEST

The maximum internal pressure which a hose can be subjected to without permanently deforming the corrugations.

PRESSURE, PULSATING

A rapid change in pressure above and below the normal base pressure, usually associated with reciprocating type pumps. This pulsating pressure can cause excessive wear between the braid and the tops of the hose convolutions.

PRESSURE, SHOCK

A sudden increase of pressure in a hydraulic or pneumatic system which produces a shock wave. This shock can cause severe permanent deformation of the hose corrugations, as well as rapid failure due to metal fatigue.

PRESSURE, STATIC

A non-changing, constant pressure.

PRESSURE, WORKING

The pressure, usually internal but sometimes external, imposed on a hose during operating conditions.

PROFILE

Used in reference to the contour rolled into the strip during the process of manufacturing stripwound hose, or the finished shape of a corrugation/convolution.

PSIA

Pounds per square inch absolute.

PSIG

Pounds per square inch gauge.

RANDOM MOTION

The uncontrolled motion of a metal hose, such as occurs in manual handling.

REUSABLE FITTING (See MECHANICAL FITTING)

Technical Information (Definitions)

SAFETY FACTOR

The relationship of working pressure to burst pressure.

SCALE

The oxide in a hose assembly brought about by surface conditions or welding.

SEAMLESS

Used in reference to corrugated metal hose which is made from a base tube that does not have a longitudinal seam.

SPLICE

A method of joining two sections of hose.

SQUARELOCKED (See INTERLOCKED)

SQUIRM

A form of failure in which the hose is deformed into an "S" or "U" bend as the result of excessive internal pressure being applied to unbraided corrugated hose while its ends are restrained, or in a braided corrugated hose which has been axially compressed.

STRESS CORROSION

A form of corrosion in stainless steel normally associated with chlorides.

STRIPWOUND (See INTERLOCKED)

TIG WELD/GTAW

The gas tungsten arc welding process sometimes referred to as a "shielded arc" or "heliarc."

TRAVELING LOOP

A general classification of bending wherein the hose is installed to a U-shaped configuration.

TRAVELING LOOP, CLASS A LOOP

An application wherein the radius remains constant and one end of the hose moves parallel to the other end.

TRAVELING LOOP, CLASS B LOOP

A condition wherein a hose is installed in a U-shaped configuration and the ends move perpendicular to each other so as to enlarge or decrease the width of the loop.

TORQUE (TORSION)

A force that produces, or tends to produce, rotation of or torsion about the longitudinal axis of a hose assembly while the other end is fixed.

VACUUM

Negative pressure or suction.

VELOCITY

The speed at which the medium flows through the hose.

VELOCITY RESONANCE

The vibration of convolutions due to the buffeting of a high velocity gas or liquid flow.

VIBRATION

Low amplitude motion occurring at high frequency.

WELDING

The process of localized joining of two or more metallic components by means of heating their surfaces to a state of fusion, or by fusion with the use of additional filler material.

Technical Information (Geometric Formulas)

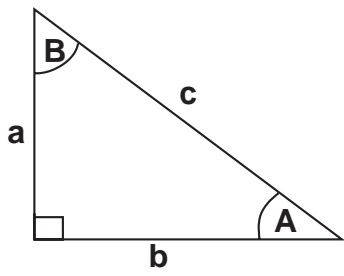
Right Triangle	<i>If Known</i>	<i>Can Determine</i>	<i>Formulas</i>
	a, b	B, A, c	$\text{Cot } B = a/b$ $\text{Tan } A = a/b$ $c = \sqrt{a^2 + b^2}$
	a, c	b, A, B	$\text{Cos } B = a/c$ $\text{Sin } A = a/c$ $b = \sqrt{(c+a)(c-a)}$
	A, a	b, B, c	$B = 90^\circ - A$ $b = a * \text{Cot } A$ $c = a/\text{Sin } A$
	b, A	B, a, c	$B = 90^\circ - A$ $a = b * \text{Tan } A$ $c = b/\text{Cos } A$
	c, A	b, a, B	$B = 90^\circ - A$ $a = c * \text{Sin } A$ $b = c * \text{Cos } A$

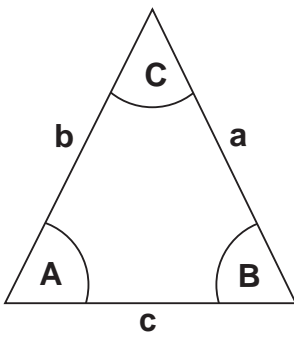
Oblique Triangle	<i>If Known</i>	<i>Can Determine</i>	<i>Formulas</i>
	a, B, A	b, c, C	$b = (a * \text{Sin } B)/\text{Sin } A$ $C = 180^\circ - (A+B)$ $c = (a * \text{Sin } C)/\text{Sin } A$
	a, A, b	B, c, C	$\text{Sin } B = (b * \text{Sin } A)/a$ $C = 180^\circ - (A+B)$ $c = (a * \text{Sin } C)/\text{Sin } A$
	a, b, C	A, B, c	$\text{Tan } A = (a * \text{Sin } C)/(b - (a * \text{Cos } C))$ $B = 180^\circ - (A+C)$ $c = (a * \text{Sin } C)/\text{Sin } A$
	a, b, c	A, B, C	$\text{Cos } A = (b^2 + c^2 - a^2)/2bc$ $\text{Cos } B = (a^2 + c^2 - b^2)/2ac$ $C = 180^\circ - (A+B)$

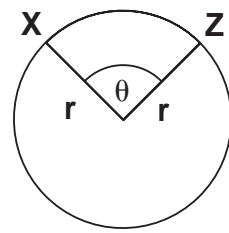
Circle	
	Area = πr^2 Where: $\pi = 3.14$ Circumference = $2\pi r$ Length of Arc XZ = $\theta * (\pi/180) * r$

Technical Information (Conversions)

Linear		
From	To	Multiply By
in.	mm	25.4
in.	cm	2.54
in.	m	.0254
ft.	mm	304.8
ft.	cm	30.48
ft.	m	.3048
yd.	mm	914.4
yd.	cm	91.44
yd.	m	.9144
mm	in.	.03937
mm	ft.	.00328
mm	yd.	.00109
cm	in.	.3937
cm	ft.	.0328
cm	yd.	.01094
m	in.	39.37
m	ft.	3.281
m	yd.	1.094

Temperature		
From	To	Multiply By
°F	°C	(°F-32)/1.8
°C	°F	(°C×1.8)+32

Weight		
From	To	Multiply By
oz(avdp)	gm	28.35
oz(avdp)	lb.	.0625
oz(avdp)	kilogram	.02835
lb.	gm.	453.6
lb.	oz(avdp)	16
lb.	kilogram	.4536
kilogram	lb.	2.205
kilogram	oz(avdp)	35.274
gram	oz(avdp)	.03274
gram	lb.	.0022
gram	kilogram	.001

Pressure		
From	To	Multiply By
atmospheres	psi	14.70
N/m ²	psi	.000145
Pascal	psi	.000145
Kilopascal	psi	.14504
Megapascal	psi	145.04
Bar	psi	14.504
In. water	psi	.03613
In. mercury	psi	.4912
Torr	psi	.01934
Kg/cm ²	psi	14.223
Kg/m ²	psi	.00142
Dynes/cm ²	psi	.000014
Lb/ft ²	psi	.00694
psi	atmospheres	.06804
psi	N/m ²	6894.8
psi	Pascal	6894.8
psi	Kilopascal	6.895
psi	Megapascal	.006895
psi	Bar	.06895
psi	In.Water	27.684
psi	In/Mercury	2.036
psi	Torr	51.715
psi	Kg/cm ²	.07031
psi	Kg/m ²	703.067
psi	Dynes/cm ²	68947.6

Velocity		
From	To	Multiply By
in/sec	cm/sec	2.54
in/min	cm/min	2.54
ft/sec	m/sec	.3048
ft/min	m/min	.3048
mile/hr	kilometer/hr	1.609
kilometer/hr	mile/hr	.6214

Volume		
From	To	Multiply By
in ³	mm ³	16387.06
in ³	cm ³	16.39
in ³	m ³	.000016
in ³	ft ³	.00058
in ³	ounce (fluid)	.5540
in ³	liter	.01639
in ³	gal	.00433
in ³	lb. water	.03613
ft ³	in ³	1728
ft ³	m ³	.02832
ft ³	gal	7.481
ft ³	lb. water	62.42
ft ³	liter	28.316
mm ³	in ³	.000061
cm ³	in ³	.06102
m ³	in ³	61023.4
m ³	ft ³	35.314
gal	in ³	231
gal	ft ³	.1337
gal	liter	3.785
liter	in ³	61.02
liter	ft ³	.0351
liter	ounce (fluid)	33.815
liter	gal	.2642
ounce (fluid)	in ³	1.805
ounce (fluid)	liter	.0296
lb. water	in ³	27.68
lb. water	ft ³	.01602
lb. water	gal	.1198

Technical Information (Working Pressure Derating Factor)

To calculate a working pressure derated for elevated temperature, multiply the hose working pressure shown in the catalog by the appropriate derating factor below.

Note: The working pressure of an assembly at elevated temperatures may be affected by fitting type, material, and method of attachment.

Temperature in Degrees F	Working Pressure Derating Factor				
	T321/T316L	T304	276	Carbon Steel	Bronze
70	1.00	1.00	1.00	1.00	1.00
150	.97	.96	1.00	.99	.92
200	.94	.92	1.00	.97	.89
250	.92	.91	1.00	.96	.86
300	.88	.86	.94	.93	.83
350	.86	.85	.92	.91	.81
400	.83	.82	.90	.87	.78
450	.81	.80	.90	.86	.75
500	.78	.77	.89	.81	
600	.74	.73	.84	.74	
700	.70	.69	.79	.66	
800	.66	.64	.76	.52	
900	.62	.58	.74	.50	
1000	.60		.72		
1100	.58		.49		
1200	.55		.32		
1300	.50				
1400	.44				
1500	.40				

Technical Information (Velocity in Metal Hose)

When gas or liquid being conveyed in a corrugated metal hose exceeds certain limits, resonant vibration can occur. Resonance may cause very rapid failure of the assembly. In those applications where product velocities exceed the limits shown in the graph below, a revision of the assembly design might include:

1. Addition of an interlocked metal hose liner
2. An increase in the corrugated hose I.D.
3. A combination of the above

INSTALLATION CONFIGURATION	MAXIMUM PRODUCT VELOCITY (FEET/SECOND)			
	UNBRAIDED		BRAIDED	
	DRY GAS	LIQUID	DRY GAS	LIQUID
STRAIGHT RUN	100	50	150	75
45 DEGREE BEND	75	40	115	60
90 DEGREE BEND	50	25	75	40
180 DEGREE BEND	25	12	38	19

Technical Information (Minimum Bend Radius Charts)

Annuflex Series AF4750, AF5750, and AF7750

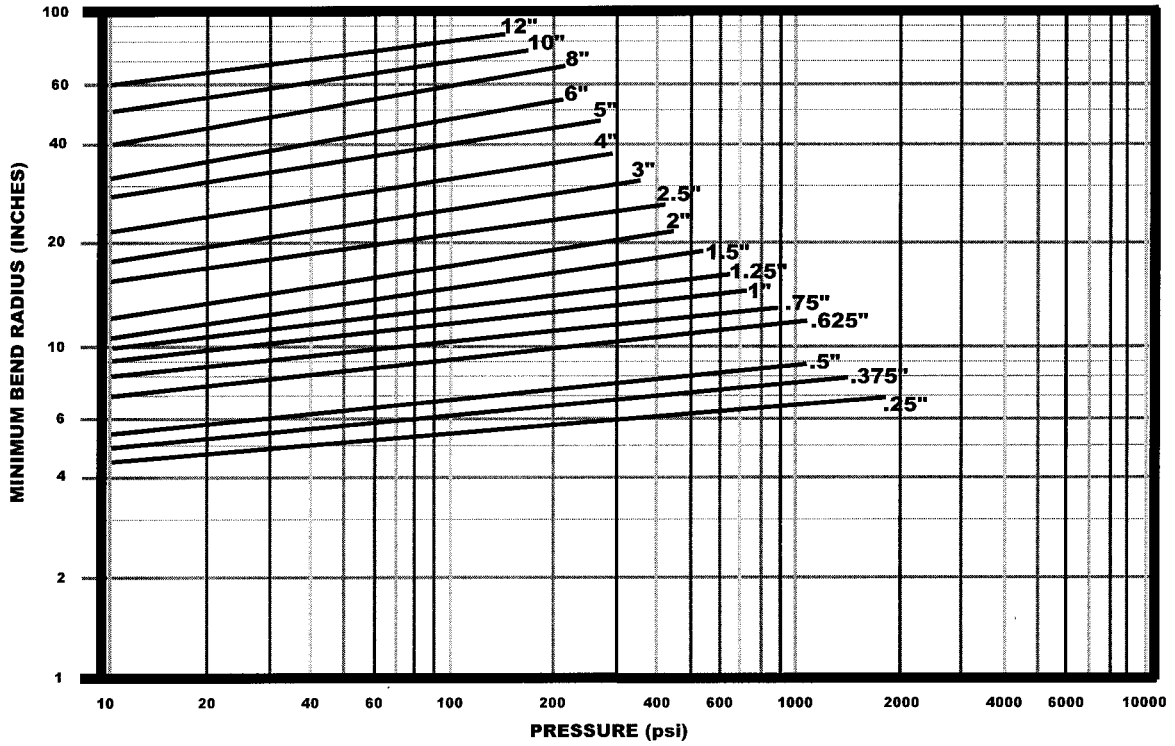

Masterflex Series AF4550, AF5550, and AF7550

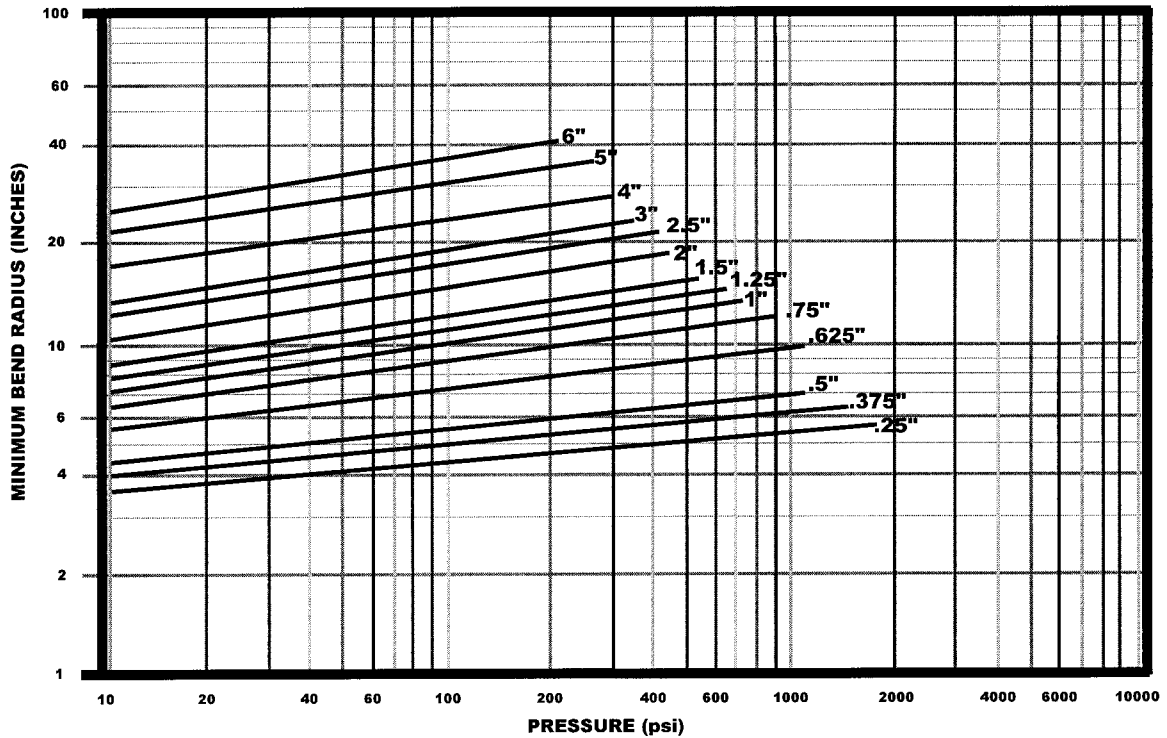

Call 1-800-221-2319
www.hosemaster.com



Technical Information (Minimum Bend Radius Charts)

Pressureflex Series AF8750

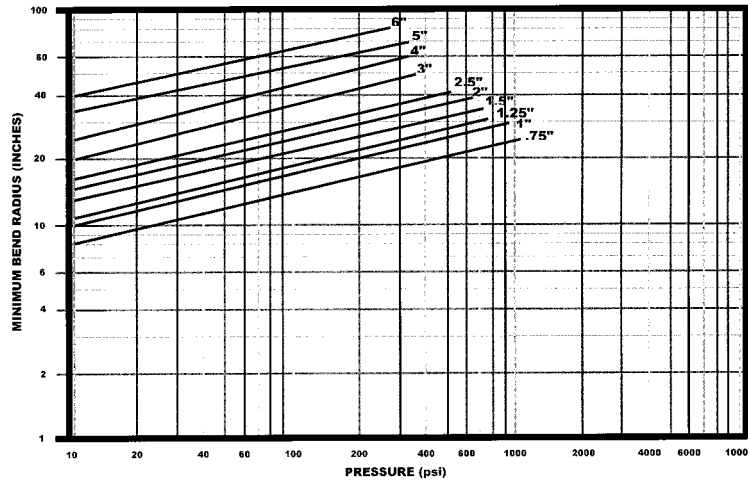

ChemKing® Series AF6740

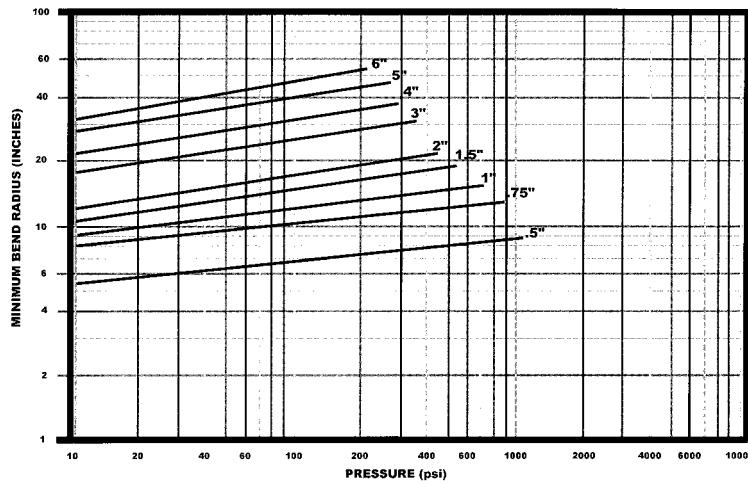

Bronzeflex Series BF1110

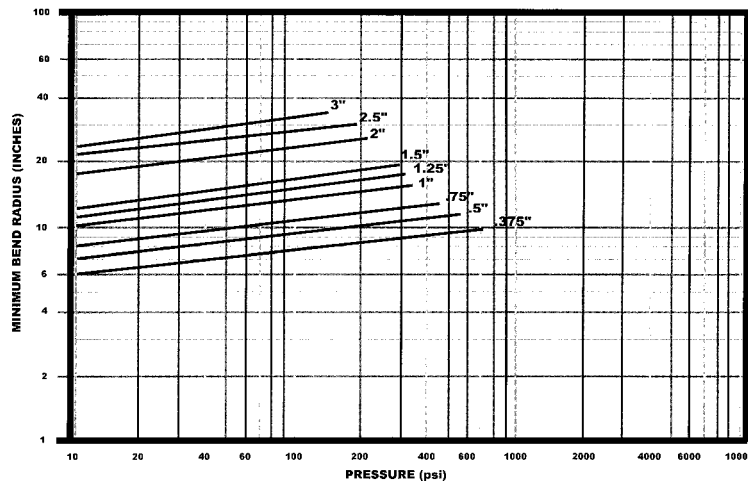

Technical Information (Minimum Bend Radius Charts)

Extraflex Series EF9050 and EF3050

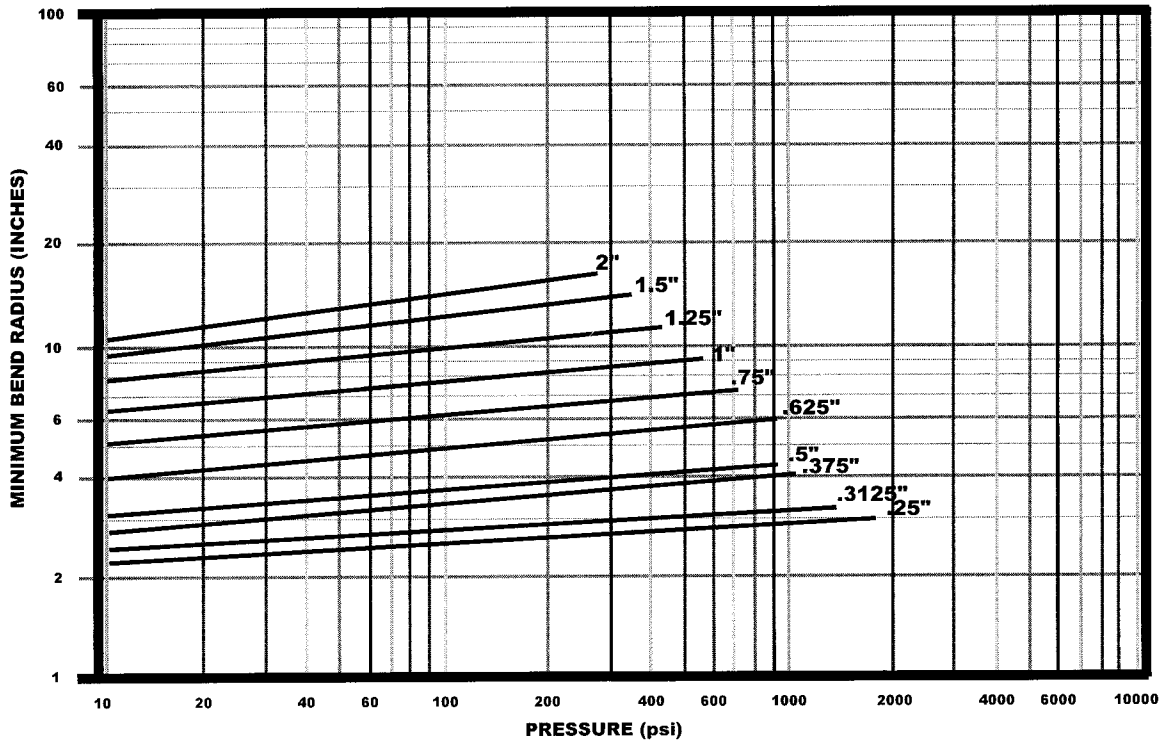

Hydraflex Series HF3450

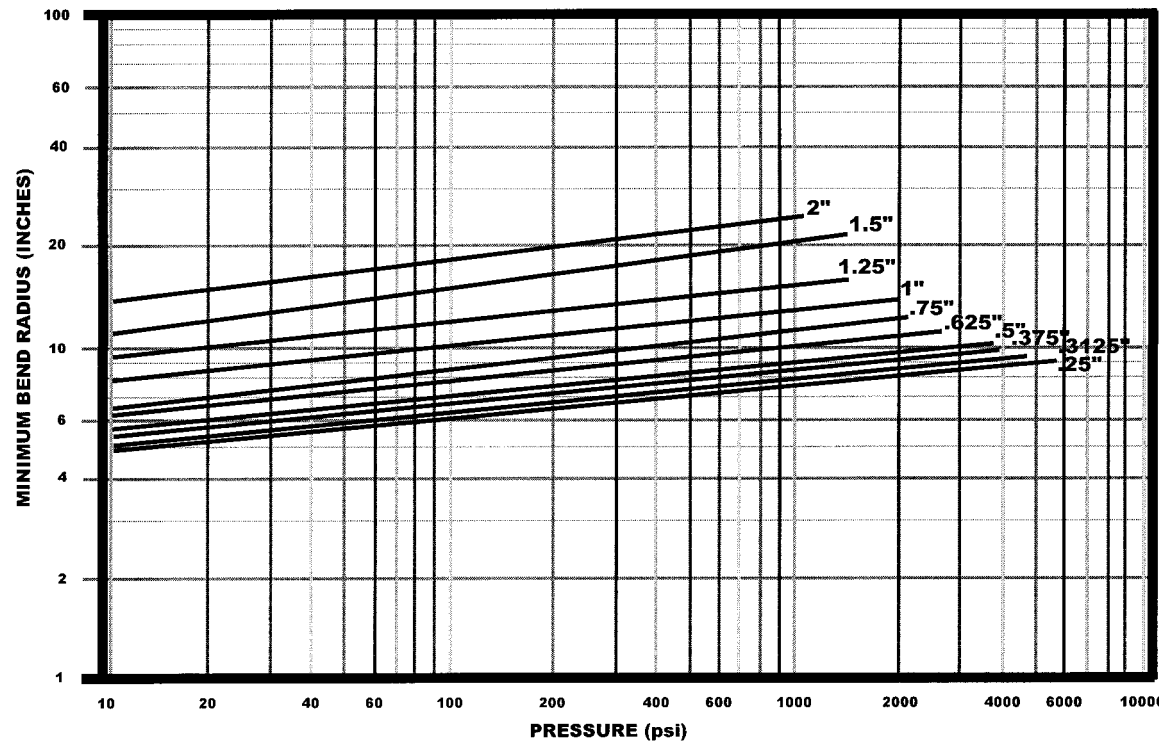

Call 1-800-221-2319
www.hosemaster.com 

Technical Data

Technical Information (Vibration)

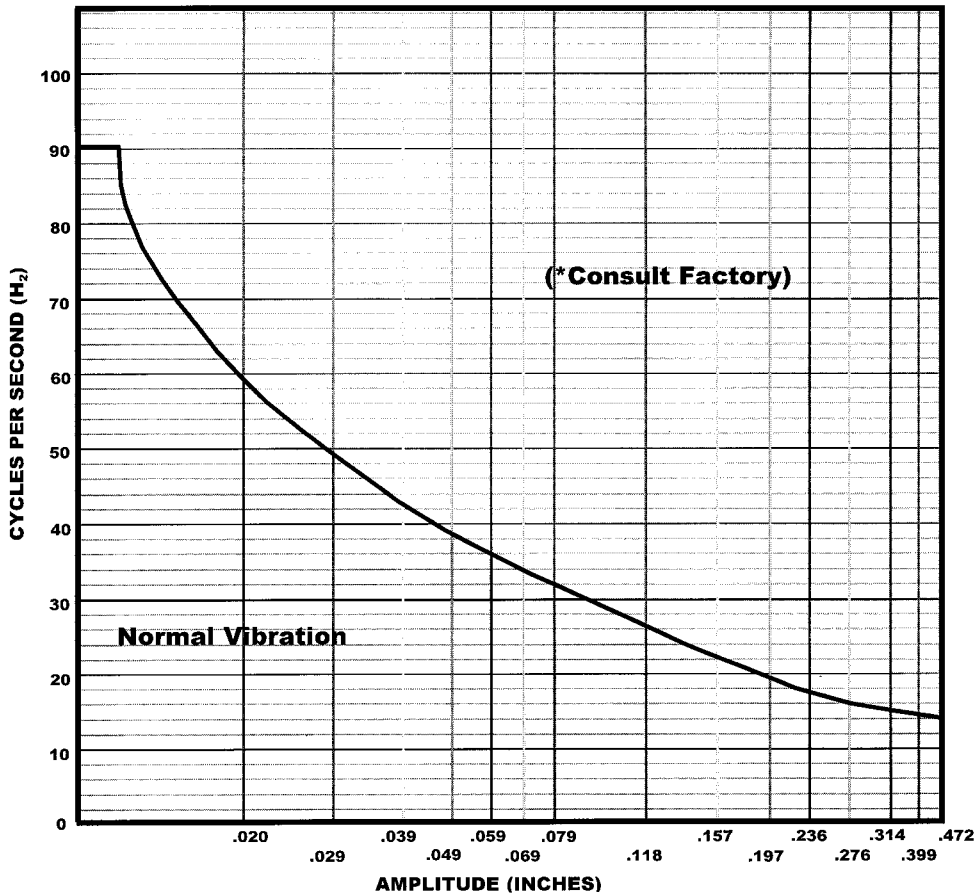

*The above graph is representative and should only be used as a guide for estimation purposes. If there are any questions, or your application is near the "consult factory" region, please contact Hose Master Customer Service.

When installing a hose assembly in a vibration application, make sure to install it so that the axis of the hose is perpendicular to the direction of the vibration.

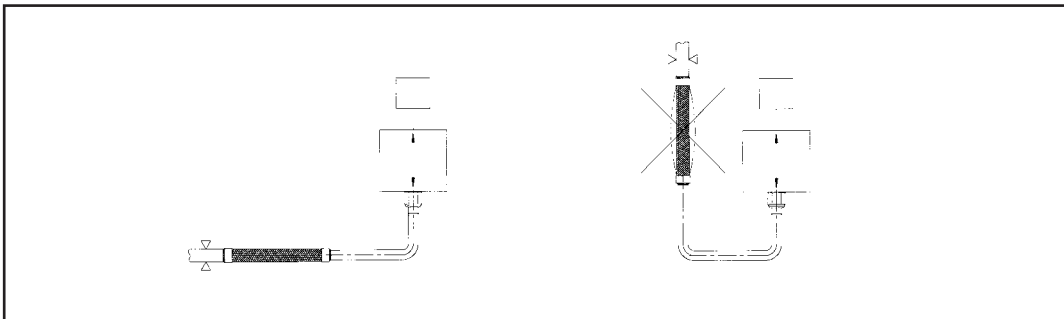

If there is vibration in more than one direction, either install a longer hose bent at 90° or install a "Dog Leg" assembly.

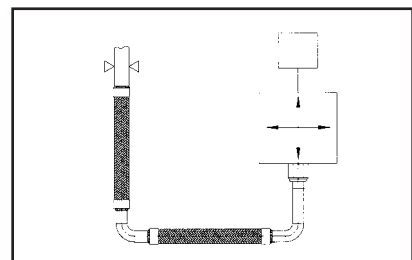
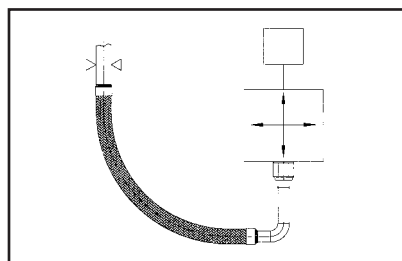
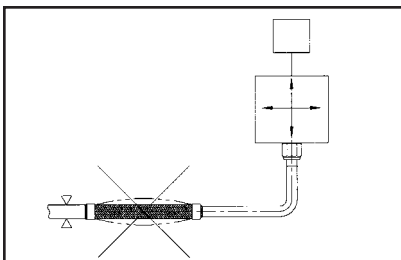

HM Call 1-800-221-2319
www.hosemaster.com

Technical Information (Do's and Don'ts)

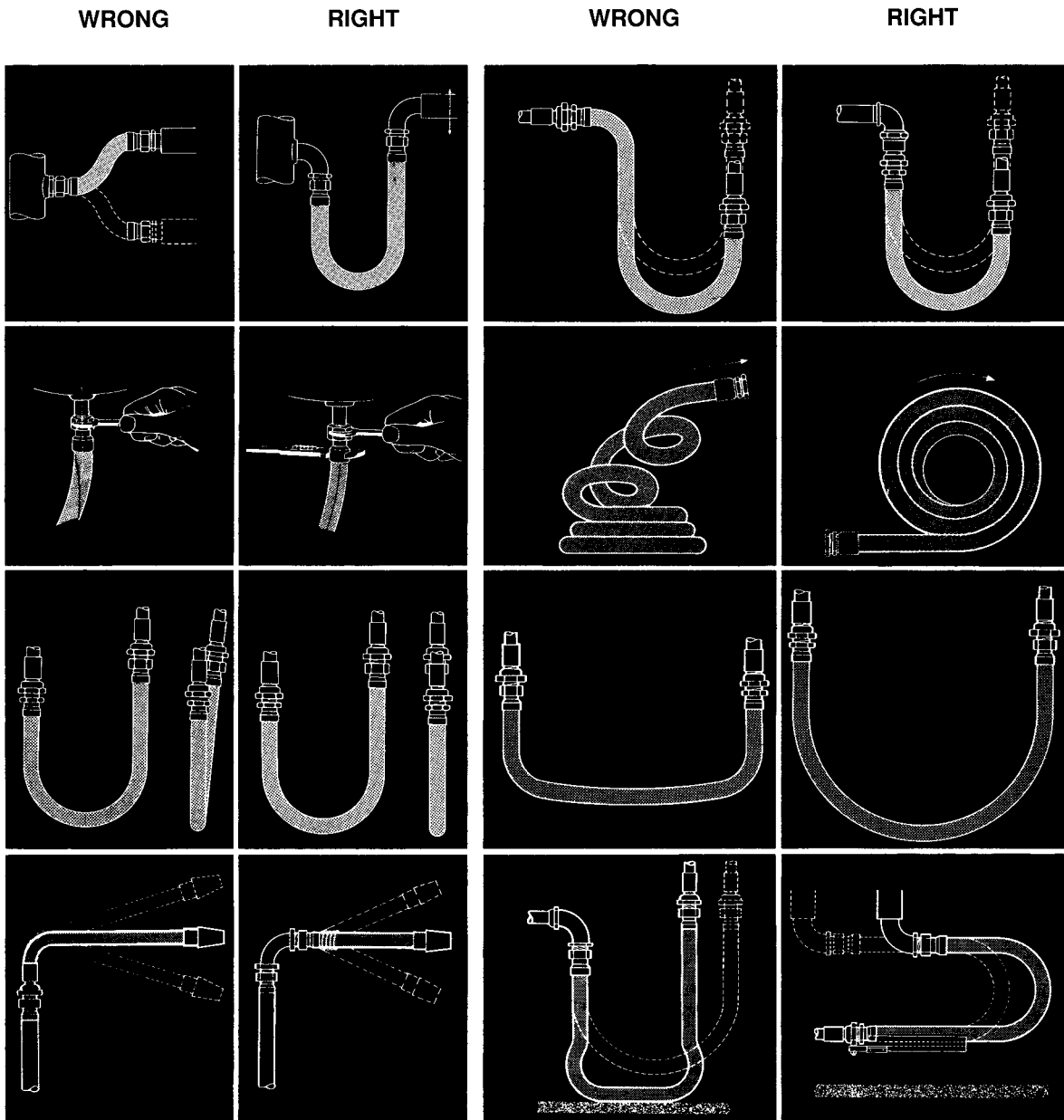

Technical Information (Thread Allowance)

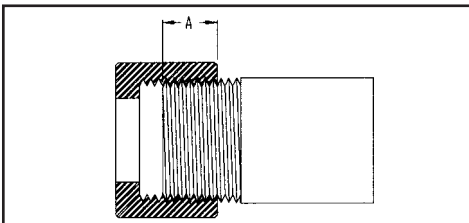

When calculating the overall length (OAL) of a hose assembly that has a pipe thread as one or both end connection(s), consideration must be given to thread engagement. For example, using the chart below, a hose assembly with a 1" male pipe on one end would have 0.66" added to the OAL to compensate for the length of thread that will be engaged during installation.

Nominal Pipe Size (in.)	1/4	3/8	1/2	3/4	1	1-1/4	1-1/2	2	2-1/2	3	4	5	6
Thread Allowance (in.) (Dim "A")	0.40	0.41	0.53	0.55	0.66	0.68	0.68	0.70	0.93	1.01	1.09	1.18	1.20

Call 1-800-221-2319
www.hosemaster.com



Technical Information (Length Calculations)

For the following formulas:

- L** = Live Length of Hose (inches)
- T** = Travel (inches)
- S** = Hose Outside Diameter (see specification sheets)

Verify that the installed radius is less than the stated Minimum Bend Radius for the hose at the required working pressure.

Constant Radius Traveling Loop (A-Loop) Formula: $L = 4R + 1/2T$

A. Vertical Travel

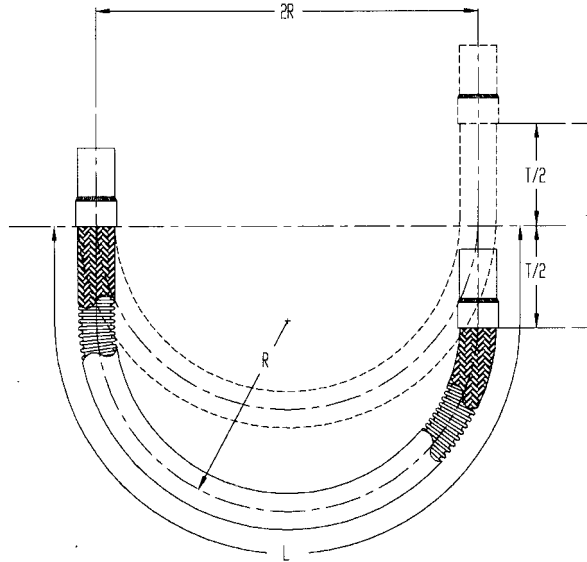

B. Horizontal Travel

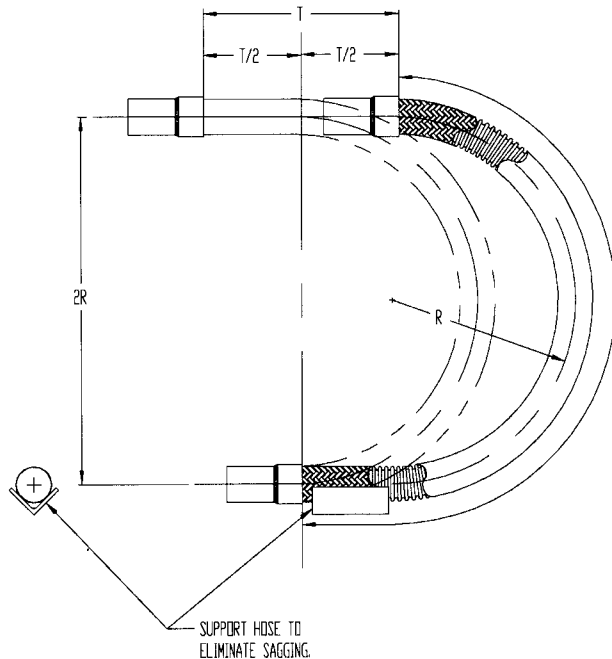

Technical Information (Length Calculations)

Variable Radius Traveling Loop (B-Loop) Formula: $L = 4R + 1.57T$

A. Vertical Travel

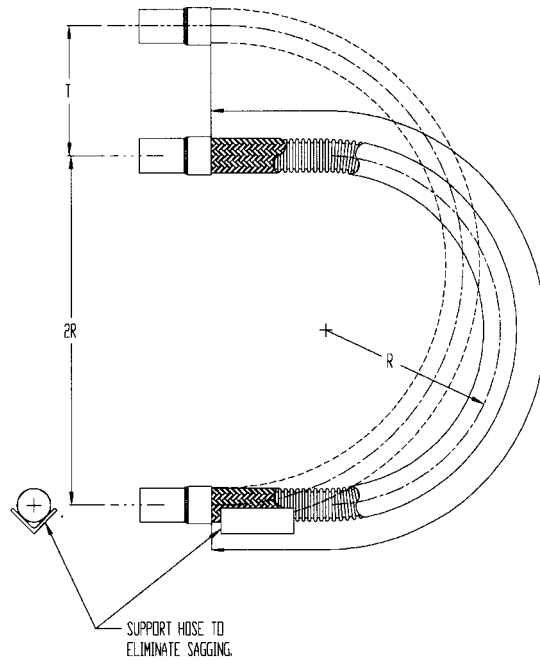

B. Horizontal Travel

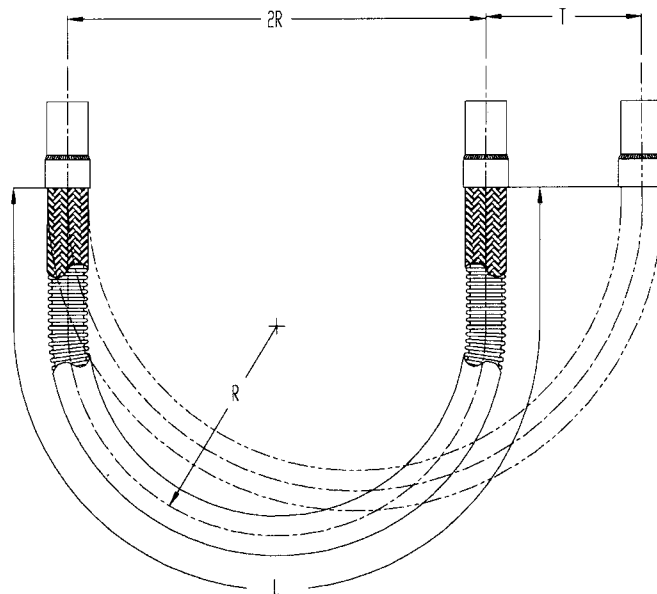

Call 1-800-221-2319
www.hosemaster.com



Technical Information (Length Calculations)

Lateral Offset

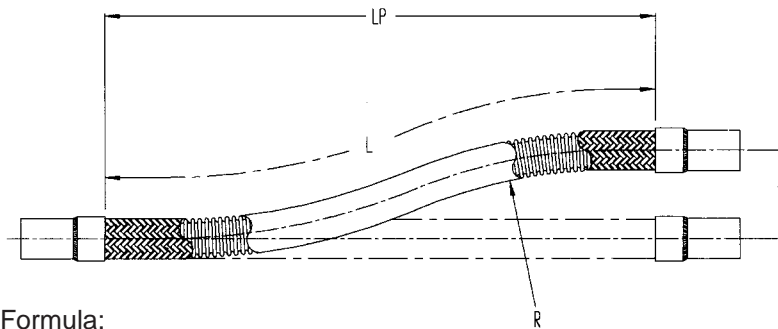

Formula:

$$L = \sqrt{20R \times T}$$

$$L_p = \sqrt{L^2 - T^2}$$

Note 1: When the offset motion occurs on both sides of the hose centerline, use total travel in the formula.

Note 2: The offset distance "T" for constant flexing should never exceed 25% of the centerline bend radius.

Angular Deflection

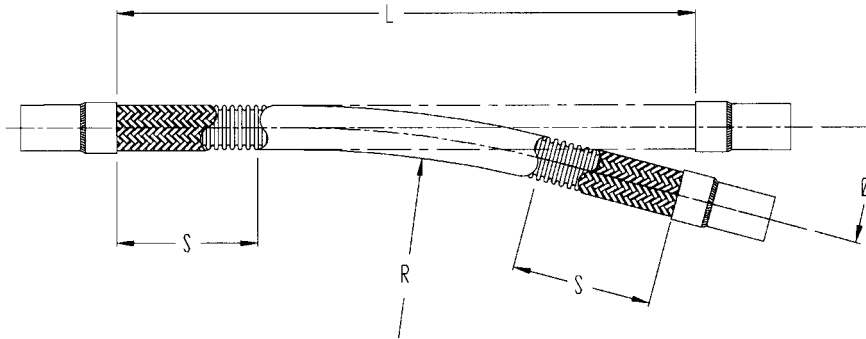

Formula:

$$L = 2S + (\theta/57.3)R$$

Vertical Loop with Movement in Two Directions (Combination Loop)

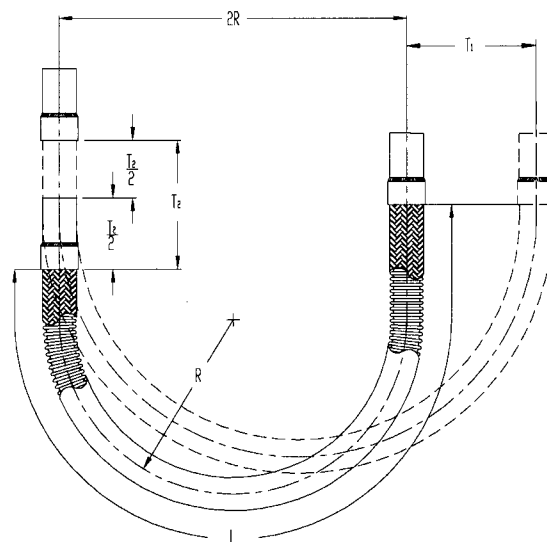

Formula:

$$L = 4R + 1.57T_1 + (T_2/2)$$

Technical Information (Pressure Drop)

Pressure drop in a piping system is often a concern of the designer. Compared to rigid pipe, there is always a greater pressure drop in corrugated metal hose. The following graphs are offered as aids in estimating pressure drop in corrugated hose conveying water and air. The values derived are approximate and apply only to straight line installations. Bends and fittings can increase the pressure drop.

PRESSURE DROP GRAPH FOR WATER

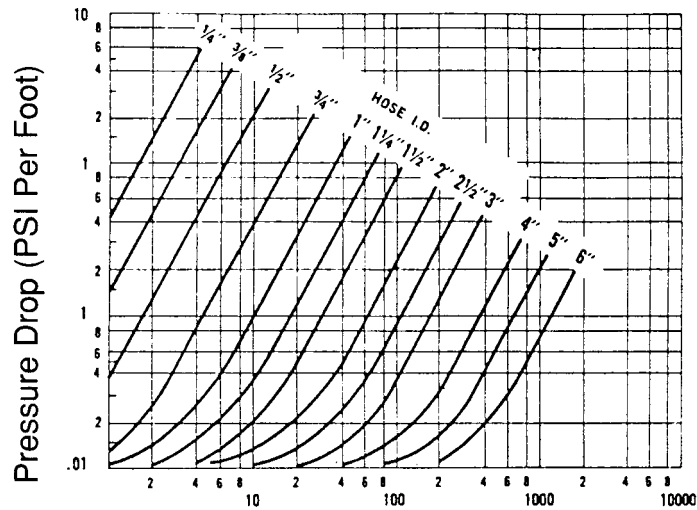

Fluid Velocity (Gals. Per Minute) Water at 70° F

PRESSURE DROP GRAPH FOR AIR

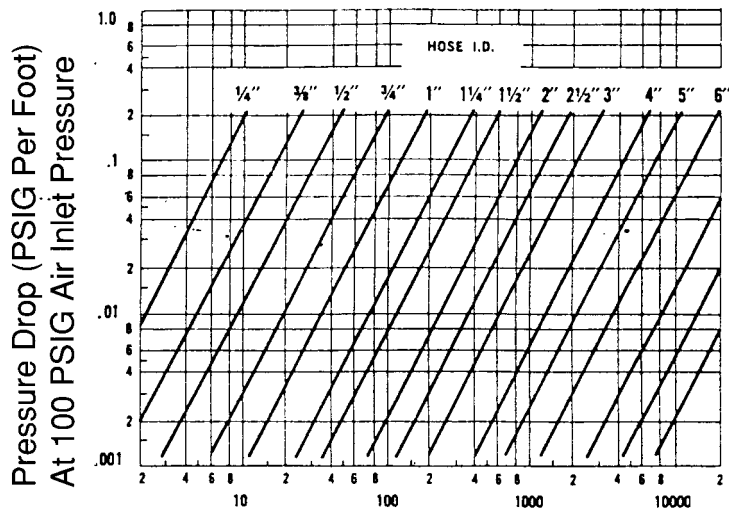

Cubic Feet Per Minute of Free Air at 60° F

FOR AIR INLET PRESSURES OTHER THAN 100 PSIG:

$$P.D. = P.D. @ 100 \text{ PSIG} \left(\frac{100 + 14.7}{P + 14.7} \right)$$

Call 1-800-221-2319
www.hosemaster.com



Technical Information (Saturated Steam)

ABSOLUTE PRESSURE (PSIA)	GAGE PRESSURE (PSIG)	TEMPERATURE DEGREES FAHRENHEIT	TEMPERATURE DEGREES CENTIGRADE	SPECIFIC VOLUME (Cu. ft. per lb.)	ABSOLUTE PRESSURE (PSIA)	GAGE PRESSURE (PSIG)	TEMPERATURE DEGREES FAHRENHEIT	TEMPERATURE DEGREES CENTIGRADE	SPECIFIC VOLUME (Cu. ft. per lb.)
15	0.3	213	101	26.3	180	165.3	373	189	2.5
20	5.3	228	109	20.1	190	175.3	378	192	2.4
25	10.3	240	116	16.3	200	185.3	382	194	2.3
30	15.3	250	121	13.7	210	195.3	386	197	2.2
35	20.3	259	126	11.9	220	205.3	390	199	2.1
40	25.3	267	130	10.5	230	215.3	394	201	2.0
45	30.3	274	134	9.4	240	225.3	397	203	1.9
50	35.3	281	138	8.5	250	235.3	401	205	1.8
55	40.3	287	142	7.8	260	245.3	404	207	1.8
60	45.3	293	145	7.2	270	255.3	408	209	1.7
65	50.3	298	148	6.7	280	265.3	411	211	1.7
70	55.3	303	151	6.2	290	275.3	414	212	1.6
75	60.3	308	153	5.8	300	285.3	417	214	1.5
80	65.3	312	156	5.5	350	335.3	432	222	1.3
85	70.3	316	158	5.2	400	385.3	445	230	1.2
90	75.3	320	160	4.9	500	485.3	467	242	.9
95	80.3	324	162	4.7	550	535.3	477	247	.8
100	85.3	328	164	4.4	600	585.3	486	252	.8
105	90.3	331	166	4.2	650	635.3	495	257	.7
110	95.3	335	168	4.0	700	685.3	503	262	.7
115	100.3	338	170	3.9	750	735.3	511	266	.6
120	105.3	341	172	3.7	800	785.3	518	270	.6
125	110.3	344	173	3.6	850	835.3	525	274	.5
130	115.3	347	175	3.5	900	885.3	532	278	.5
135	120.3	350	177	3.3	950	935.3	538	281	.5
140	125.3	353	178	3.2	1000	985.3	545	285	.4
145	130.3	356	180	3.1	1050	1035.3	551	288	.4
150	135.3	358	181	3.0	1100	1085.3	556	291	.4
160	145.3	364	184	2.8	1150	1135.3	562	294	.4
170	155.3	368	187	2.7	1200	1185.3	567	297	.4

Technical Information (Thermal Expansion of Pipe)

(ANSI B31.1.0-1967)

Temp range: 70° F (21° C) to

Material	Coef- ficient	70 (21)	200 (93)	300 (149)	400 (205)	500 (260)	600 (316)	700 (371)	800 (427)	900 (482)	1000 (538)	1100 (593)	1200 (649)	1300 (705)	1400 (760)
Carbon steel: carbon-moly steel low-chrome steels (through 3% Cr)	A		6.38	6.60	6.82	7.02	7.23	7.44	7.65	7.84	7.97	8.12	8.19	8.28	8.36
	B	0	0.99	1.82	2.70	3.62	4.60	5.63	6.70	7.81	8.89	10.04	11.10	12.22	13.34
Intermediate alloy steels: 5 Cr Mo-9 Cr Mo	A		6.04	6.19	6.34	6.50	6.66	6.80	6.96	7.10	7.22	7.32	7.41	7.49	7.55
	B	0	0.94	1.71	2.50	3.35	4.24	5.14	6.10	7.07	8.06	9.05	10.00	11.06	12.05
Austenitic stainless steels	A		9.34	9.47	9.59	9.70	9.82	9.92	10.05	10.16	10.29	10.39	10.48	10.54	10.60
	B	0	1.46	2.61	3.80	5.01	6.24	7.50	8.80	10.12	11.48	12.84	14.20	15.56	16.92
Straight chromium stainless steels: 12 Cr, 17 Cr, and 27 Cr	A		5.50	5.66	5.81	5.96	6.13	6.26	6.39	6.52	6.63	6.72	6.78	6.85	6.90
	B	0	0.86	1.56	2.30	3.08	3.90	4.73	5.60	6.49	7.40	8.31	9.20	10.11	11.01
25 Cr-20 Ni	A		7.76	7.92	8.08	8.22	8.38	8.52	8.68	8.81	8.92	9.00	9.08	9.12	9.18
	B	0	1.21	2.18	3.20	4.24	5.33	6.44	7.60	8.78	9.95	11.12	12.31	13.46	14.65
Monel 67: Ni-30 Cu	A		7.84	8.02	8.20	8.40	8.58	8.78	8.96	9.16	9.34	9.52	9.70	9.88	10.04
	B	0	1.22	2.21	3.25	4.33	5.46	6.64	7.85	9.12	10.42	11.77	13.15	14.58	16.02
Monel 66: Ni-29 CuAl	A		7.48	7.68	7.90	8.09	8.30	8.50	8.70	8.90	9.10	9.30	9.50	9.70	9.89
	B	0	1.17	2.12	3.13	4.17	5.28	6.43	7.62	8.86	10.16	11.50	13.00	14.32	15.78
Aluminum	A		12.95	13.28	13.60	13.90	14.20								
	B	0	2.00	3.66	5.39	7.17	9.03								
Gray cast iron	A		5.75	5.93	6.10	6.28	6.47	6.65	6.83	7.00	7.19				
	B	0	0.90	1.64	2.42	3.24	4.11	5.03	5.98	6.97	8.02				
Bronze	A		10.03	10.12	10.23	10.32	10.44	10.52	10.62	10.72	10.80	10.90	11.00		
	B	0	1.56	2.79	4.05	5.33	6.64	7.95	9.30	10.68	12.05	13.47	14.92		
Brass	A		9.76	10.00	10.23	10.47	10.69	10.92	11.16	11.40	11.63	11.85	12.09		
	B	0	1.52	2.76	4.05	5.40	6.80	8.26	9.78	11.35	12.98	14.65	16.39		
Wrought iron	A		7.32	7.48	7.61	7.73	7.88	8.01	8.13	8.29	8.39				
	B	0	1.14	2.06	3.01	3.99	5.01	6.06	7.12	8.26	9.36				
Copper-nickel (70/30)	A		8.54	8.71	8.90										
	B	0	1.33	2.40	3.52										

A = mean coefficient of thermal expansion x 10⁶, in/in°F in going from 70°F (21°C) to indicated temperature
 B = linear thermal expansion, in/100 ft going from 70°F (21°C) to indicated temperature

Multiply values of A shown by 1.8 to obtain coefficient of expansions in cm/cm°C.
 Multiply values of B shown by 8.33 to obtain linear expansion in cm per 100 m.

